



Peelers

Model PE-BR-0010

Item 13443

Instruction Manual



Revised - 07/08/2024



Toll Free: 1-800-465-0234
Fax: 905-607-0234
Email: service@omcan.com
www.omcan.com



Table of Contents

Model PE-BR-0010

Section	Page
General Information -----	3 - 4
Safety and Warranty -----	4 - 5
Technical Specifications -----	6
Installation -----	6
Operation -----	6 - 7
Maintenance -----	7 - 8
Parts Breakdown -----	9 - 11
Electrical Schematics -----	12
Notes -----	13 - 14
Warranty Registration -----	15



General Information

Omcan Manufacturing and Distributing Company Inc., Food Machinery of America, Inc. dba Omcan and Omcan Inc. are not responsible for any harm or injury caused due to any person's improper or negligent use of this equipment. The product shall only be operated by someone over the age of 18, of sound mind, and not under the influence of any drugs or alcohol, who has been trained in the correct operation of this machine, and is wearing authorized, proper safety clothing. Any modification to the machine voids any warranty, and may cause harm to individuals using the machine or in the vicinity of the machine while in operation.

CHECK PACKAGE UPON ARRIVAL

Upon receipt of an Omcan shipment please inspect for external damage. If no damage is evident on the external packaging, open carton to ensure all ordered items are within the box, and there is no concealed damage to the machine. If the package has suffered rough handling, bumps or damage (visible or concealed), please note it on the bill of lading before accepting the delivery and contact Omcan within 24 hours, so we may initiate a claim with the carrier. A detailed report on the extent of the damage caused to the machine must be filled out within three days, from the delivery date shown in the shipping documents. Omcan has no recourse for damaged products that were shipped collect or third party.

Before operating any equipment, always read and familiarize yourself with all operation and safety instructions.

Omcan would like to thank you for purchasing this machine. It's of the utmost importance to save these instructions for future reference. Also save the original box and packaging for shipping the equipment if servicing or returning of the machine is required.

Omcan Fabrication et distribution Compagnie Limité et Food Machinery d'Amérique, dba Omcan et Omcan Inc. ne sont pas responsables de tout dommage ou blessure causé du fait que toute personne ait utilisé cet équipement de façon irrégulière. Le produit ne doit être exploité que par quelqu'un de plus de 18 ans, sain d'esprit, et pas sous l'influence d'une drogue ou d'alcool, qui a été formé pour utiliser cette machine correctement, et est vêtu de vêtements de sécurité appropriés. Toute modification de la machine annule toute garantie, et peut causer un préjudice à des personnes utilisant la machine ou des personnes à proximité de la machine pendant son fonctionnement.

VÉRIFIEZ LE COLIS DÈS RÉCEPTION

Dès réception d'une expédition d'Omcan veuillez inspecter pour dommages externes. Si aucun dommage n'est visible sur l'emballage externe, ouvrez le carton afin de s'assurer que tous les éléments commandés sont dans la boîte, et il n'y a aucun dommage dissimulé à la machine. Si le colis n'a subi aucune mauvaises manipulations, de bosses ou de dommages (visible ou cachée), notez-le sur le bond de livraison avant d'accepter la livraison et contactez Omcan dans les 24 heures qui suivent, pour que nous puissions engager une réclamation auprès du transporteur. Un rapport détaillé sur l'étendue des dommages causés à la machine doit être rempli dans un délai de trois jours, à compter de la date de livraison indiquée dans les documents d'expédition. Omcan n'a aucun droit de recours pour les produits endommagés qui ont été expédiés ou cueillis par un tiers transporteur.

Avant d'utiliser n'importe quel équipement, toujours lire et vous familiariser avec toutes les opérations et les

General Information

consignes de sécurité.

Omcán voudrais vous remercier d'avoir choisi cette machine. Il est primordial de conserver ces instructions pour une référence ultérieure. Également conservez la boîte originale et l'emballage pour l'expédition de l'équipement si l'entretien ou le retour de la machine est nécessaire.

Omcán Empresa De Fabricación Y Distribución Inc. Y Maquinaria De Alimentos De América, Inc. dba Omcán y Omcán Inc. no son responsables de ningún daño o perjuicio causado por cualquier persona inadecuada o el uso descuidado de este equipo. El producto solo podrá ser operado por una persona mayor de 18 años, en su sano juicio y no bajo alguna influencia de droga o alcohol, y que este ha sido entrenado en el correcto funcionamiento de esta máquina, y ésta usando ropa apropiada y autorizada. Cualquier modificación a la máquina anula la garantía y puede causar daños a las personas usando la máquina mientras esta en el funcionamiento.

REVISE EL PAQUETE A SU LLEGADA

Tras la recepción de un envío Omcán favor inspeccionar daños externos. Si no hay daños evidentes en el empaque exterior, abra el cartón para asegurarse que todos los artículos solicitados estén dentro de la caja y no encuentre daños ocultos en la máquina. Si el paquete ha sufrido un manejo de poco cuidado, golpes o daños (visible o oculto) por favor anote en la factura antes de aceptar la entrega y contacte Omcán dentro de las 24 horas, de modo que podamos iniciar una reclamación con la compañía. Un informe detallado sobre los daños causados a la máquina debe ser llenado en el plazo de tres días, desde la fecha de entrega que se muestra en los documentos de envío. Omcán no tiene ningún recurso por productos dañados que se enviaron a recoger por terceros.

Antes de utilizar cualquier equipo, siempre lea y familiarizarse con todas las instrucciones de funcionamiento y seguridad.

Omcán le gustaría darle las gracias por la compra de esta máquina. Es de la mayor importancia para salvar estas instrucciones para futuras consultas. Además, guarda la caja original y el embalaje para el envío del equipo si servicio técnico o devolución de la máquina que se requiere.

Safety and Warranty

MAIN PRECAUTIONS

- The peeler must be used and handled with care.
- BEFORE cleaning disconnect machine from power source.
- NEVER use tools not belonging to machine to help operation.
- The abrasive plate must be perfectly fitted onto central shaft pin.
- BE CAREFUL when handling the abrasive plate, it is heavy and may hurt if dropped.
- DO NOT put your hands inside machine during operation.

Safety and Warranty

- NEVER connect power source with wet hands nor wet clothes.
- NEVER spray water or other liquid substances directly at motor, power switch or any other electrical components.
- ALWAYS install equipment in working area with adequate light and space away from children and visitors.
- NEVER operate without all warning labels attached and owner/operator manual available to operator.
- NEVER leave unattended while operating.
- ALWAYS ground machine properly.
- DO NOT process frozen foods or other products other than potatoes and carrots.
- NEVER lift lid before being sure abrasive plate is completely still.

GENERAL ADVICE

- ALWAYS turn machine off before cleaning and maintenance.
- PROVIDE enough space around machine to avoid accidents.
- ALWAYS keep the floor dry. Wet floors may cause slips.
- ALWAYS turn machine off in case of power supply lack.
- NEVER let dust or water to get into electrical and mechanical components of the machine.
- DO NOT modify original features of the machine.
- DO NOT take out nor tear off any safety or identification label.

RESIDENTIAL USERS: vendor assumes no liability for parts or labor coverage for component failure or other damages resulting from installation in non-commercial or residential applications. The right is reserved to deny shipment for residential usage; if this occurs, you will be notified as soon as possible.

1 YEAR PARTS AND LABOUR BENCH WARRANTY

Within the warranty period, contact Omcan Inc. at 1-800-465-0234 to schedule a drop off to either an Omcan authorized service depot in the area, or to an Omcan Service warehouse to repair the equipment.

Unauthorized maintenance will void the warranty. Warranty covers electrical and part failures, not improper use.

Please see <https://omcan.com/disclaimer> for complete info.

WARNING:

The packaging components are classified as normal solid urban waste and can therefore be disposed of without difficulty.

In any case, for suitable recycling, we suggest disposing of the products separately (differentiated waste) according to the current norms.

DO NOT DISCARD ANY PACKAGING MATERIALS IN THE ENVIRONMENT!

Technical Specifications

Model	PE-BR-0010
Item Number	13443
Power	0.5 HP / 0.37 kW
Capacity	22 lbs. / 10 kgs.
Approximate Output	440 lbs. / 199.6 kgs. per hr.
Electrical	110-120V / 60Hz / 1
Weight	75 lbs. / 34 kgs.
Packaging Weight	81.6 lbs. / 37 kgs.
Dimensions	22.8" x 19" x 28" / 580 x 483 x 711mm
Packaging Dimensions	25" x 21" x 34" / 635 x 533 x 863mm

Installation

The peeler must be installed on a level, non-skid work surface. During peeling operation food product must be wet. By means of a 3/4" pipe bring water to feeding nipple. As an alternative it is possible to place the machine below a 3/4" water faucet and let the water flow in during the operation. It is recommended to place the machine near by a water sink to allow wastes to flow out. A drainage pipe may be connected to outlet waste to flow the wastes out to the nearest sink.

Operation

PRE OPERATION

- Check voltage of the machine. The voltage must be the same as the power source voltage.
- Grounding wire must always be connected.
- Check if the machine is firm in its position. Be sure the water inlet pipe and the drainage pipe are installed properly.

OPERATION

IMPORTANT: BE SURE THE ABRASIVE PLATE IS FIRMLY FITTED ONTO CENTRAL SHAFT PIN.

First of all check if the lid is duly fitted on the top of the machine. To start machine turn switch to ON position.

Operation

Let water flows into the chamber and load it with food product. Water shall then flow out through the waste outlet. Each load shall not exceed 10 Kg in the peeler. The peeling time is from 3 to 5 minutes it depends on the hardness of the food product, its size and irregularity.

Check if products are peeled looking through the transparent lid. To remove peeled product from inside the chamber close faucet, place a container under the discharge door and open it, so that the peeled potatoes are discharged from the chamber under the action of centrifugal force applied by the peeling disc.

IMPORTANT

Under no circumstances touch the abrasive disc when it is in moving. Secure the lid, open the water tap, set the timer and activate the ON/OFF switch. With the machine on and with water falling at the center of the abrasive disc, pour the product to be processed inside it. For the PE-BR-0010, put 10 kg of potatoes at most. The working time varies from one to five minutes. If the potatoes are being peeled to irregularly, it is possible to observe the process through the lid opening. The PE-BR-0010 is designed to process normal shaped potatoes, any other vegetable with irregular shape will need a manual finishing even after processing. To remove the peeled product, keep the machine running, shut down the water and open the door by pulling the lock upwards. Lift it until the side lock and keep the door open. This way the product will be expelled. To close the door, release the side lock by pulling it sideways.

Maintenance

CLEANING

1. Turn OFF the machine and disconnect it from power source.
2. Wait until the abrasive plate is completely still.
3. To lift the abrasive plate out of the cylinder, hold it and pull it up.
4. Wash the machine and the plate with water and neutral soap.
5. To reassemble plate proceed inversely being sure of placing it back on the central shaft pin correctly.

For a fast cleaning, just turn the machine ON without load and let it work with running water.

INSTRUCTIONS TO APPLY THE GLUE KIT AND ABRASIVE MATERIAL

Important: the procedure for applying the glue and abrasive material must only be performed by a qualified repair technician. If the procedure is not performed by a qualified technician, the warranty will be void.

Kindly follow the instructions below to apply the glue kit and abrasive material to the discs.

1. Make sure that the unit is turned off and completely disconnected from any power supply. After this you can access the disc and remove it from the unit.
2. The remaining old abrasive material and kit glue still present in the disc to be renewed must be completely

Maintenance

taken out. For that heat up the disc until it reaches around 300°C of temperature for 10 minutes, this will make the remaining abrasive material and kit glue fall from the disc, a blowtorch can be used to perform this job (make sure you use all safety measures and precautions to realize this step). After that, and when the disc is in an appropriate temperature to be handled, clean all of its surface thoroughly, it must be 100% clean to receive the new kit glue and abrasive material. Failure in cleaning up the disc will result in failure to apply the new kit glue and abrasive material.

3. With the disc in cold/room temperature, distribute the already mixed glue kit on its surface in an equal manner (see point 6). With the help of a paintbrush, apply a uniform layer of the already mixed glue kit all over the superior face of the disc.

Quantities: 95g of the already mixed glue kit (code 04636.1).

4. After step 3) apply in a uniform manner, all over the superior face of the disc, a homogeneous layer of the abrasive material (code 36969.1), use the help of a sieve to help you achieve a homogenous distribution.

Quantities: 610g of abrasive material (aluminum oxide).

5. Keep the renewed disc completely still for a period of 48 hours to make sure that the glue kit and the abrasive material are totally fixed on the disc.
6. Instructions to prepare the glue kit. The glue kit is the mixing of two products:
 - Product A (araldite 65g).
 - Product B (hardener 30gr).The mixing must be done in a disposable recipient, with the help of a wooden spatula, also disposable. Mix the two products very well until the end result is completely equal and with a uniform color.

IMPORTANT

The glue kit can be stored for a maximum period of 1 year in a dry place, away from sunlight, in temperature between 18 and 25°C. Past the period informed above the glue kit properties can be lost and its use is not recommended.

Parts Breakdown

Model PE-BR-0010 13443

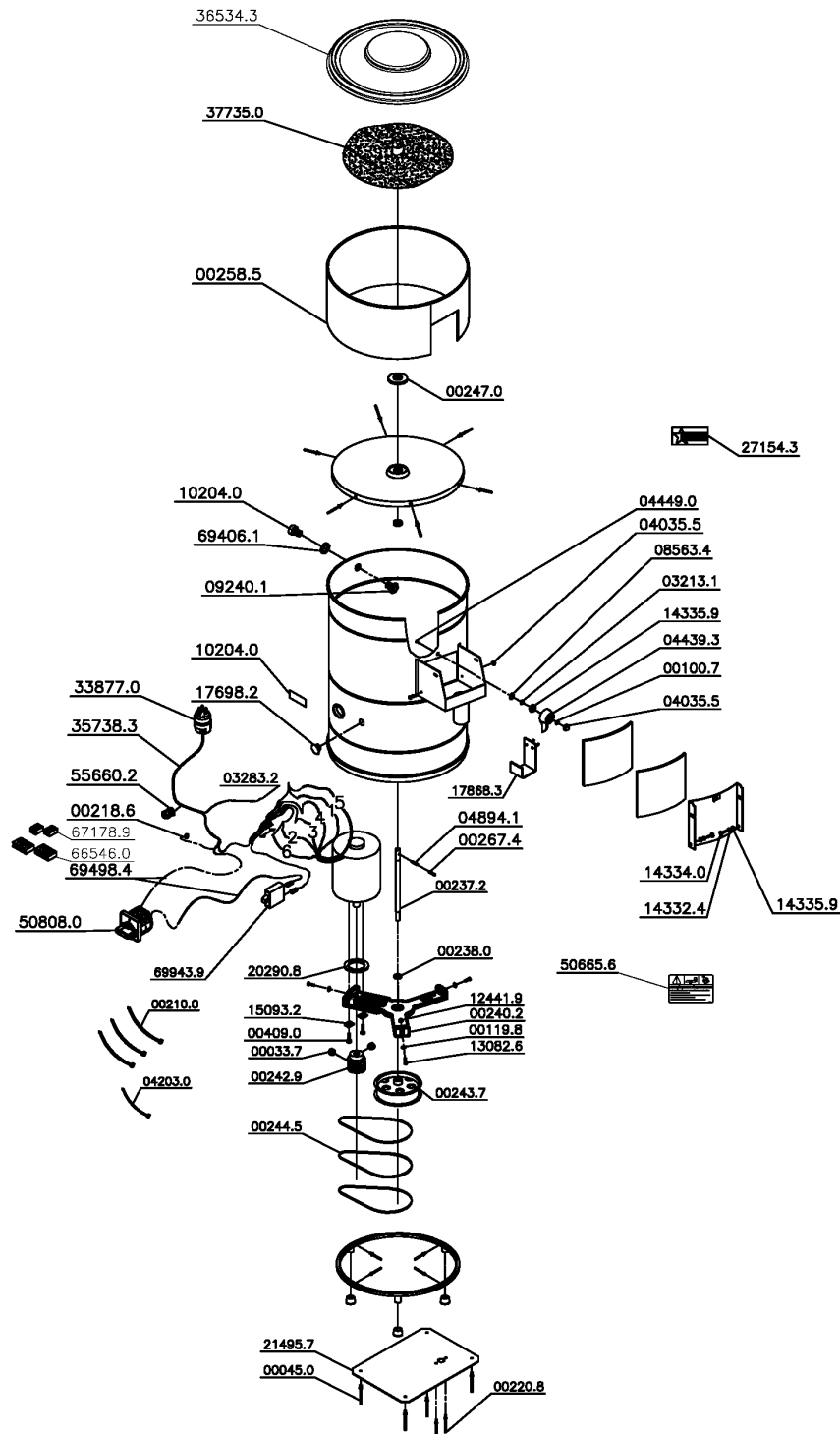

Parts Breakdown

Model PE-BR-0010 13443

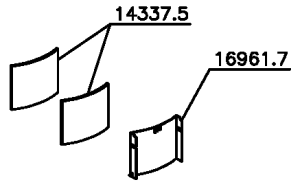
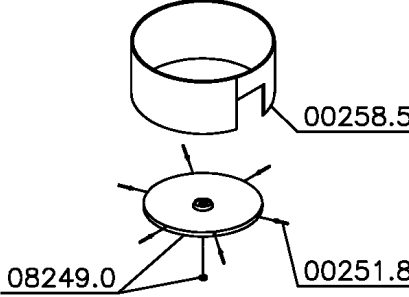
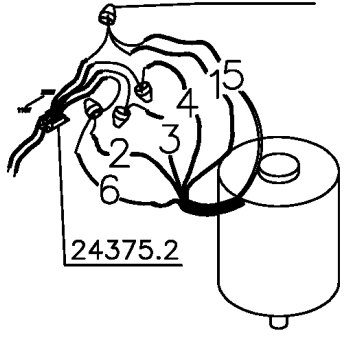
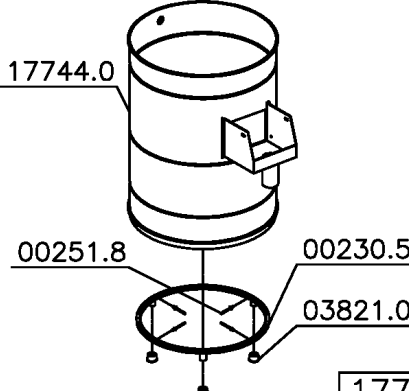
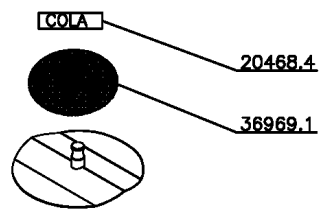
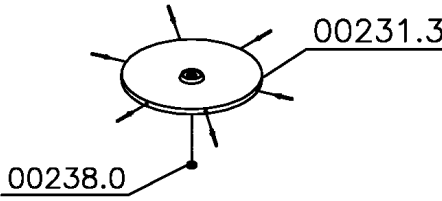
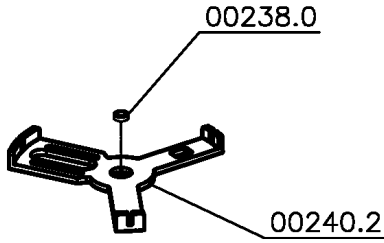
	
	
<p>Motor Complete 10903.7</p>	<p>17745.8</p>
	
<p>Abrasive disc Comp. 37735.0</p>	<p>Bottom Complete 08249.0</p>
	
	<p>Motor Support Complete 08250.3</p>

Parts Breakdown

Model PE-BR-0010 13443

Item No.	Description	Position	Item No.	Description	Position	Item No.	Description	Position
30317	Screw 1/4x1/4 for 13443	00033.7	66186	Term. Pre-Isol.AN-2434 for 13443	03283.2	78549	CS Housing for 13443	17744.0
30029	Pression Rivet AD-423-S for 13443	00045.0	16404	Pont Ext Ted 7/8 for 13443	03821.0	78553	Complete Housing for 13443	17745.8
30234	Washer L 1/4x1 6 ZB for 13443	00100.7	30341	Screw Nut 1 4 for 13443	04035.5	78548	Strip for 13443	17868.3
30258	Washer L 5/16 ZB for 13443	00119.8	27699	Cramp T 18R Small for 13443	04203.0	38114	Door with Rubber for 13443	18531.0
27688	Clamp K22 (T 50R) for 13443	00210.0	30245	Latch for 13443	04439.3	AG046	Adaptor Ring 3.96mm (Grey) for 13443	20290.8
30186	Wire Passer Molde 0922231 for 13443	00218.6	30292	PFS FCH UNC1 4x1.1 2 RTZB for 13443	04449.0	AN884	Prepared Glue for 13443	20468.4
30030	Pression Rivet AD-440-S for 13443	00220.8	14801	Central Shaft Pin 4x50 Din 1481 for 13443	04894.1	78543	Lower Closing Strip for 13443	21495.7
30354	Peeler Base for 13443	00230.5	38116	Complete Base for 13443	08249.0	18949	Select Switch 110/220V Compl. for 13443	24375.2
38117	Base for 13443	00231.3	16410	Complete Motor Support for 13443	08250.3	27720	Omcan Logo (Machines) for 13443	27154.3
62452	Central Shaft for 13443	00237.2	30286	Washer 10x28x1,5mm for 13443	08563.4	AE578	Certified American Plug 15A (3D224 for 13443)	33877.0
16396	Ball Bearing 6204 Z for 13443	00238.0	24020	Niple Set/Reduction for 13443	09240.1	AE579	CB.3x2.1mm2 SJX2M Certif. for 13443	35738.3
38110	Motor Base for 13443	00240.2	27704	ID Label Motor/Resist for 13443	10204.0	44896	Acrylic Lid for 13443	36534.3
30312	Motor Pulley for 13443	00242.9	16415	Motor 0.5HP 60 Hz 110V for 13443	10903.7	27762	Aluminum Oxide No.46 for 13443	36969.1
16397	Moved Pulley for 13443	00243.7	16418	Nut N M6 Din 985 Stainless Steel for 13443	12441.9	72278	Abrasive Disc for 13443	37735.0
16398	Belt Z 625 for 13443	00244.5	16429	Screw M6x20 for 13443	13082.6	78551	Cleaning Maintenance Label for 13443	50665.6
16399	Rubber Flange S027057EAL Mold 085286 for 13443	00247.0	30200	Distancer for 13443	14332.4	AN193	Rotary Disconnect Switch MSW 20 P2 for 13443	50808.0
30352	Pression Rivet AD 665 S for 13443	00251.8	30347	Sextavated Screw UNC1 4x1 RTIN for 13443	14334.0	AG023	Cord Press PG13.5 HSK-K Complete for 13443	55660.2
29993	Rubber Coating 1300x265x6mm for 13443	00258.5	30311	Nut Sex. 1 4 Stainless Steel for 13443	14335.9	AM613	Wago Splicing Connector 5x0.25-4mm2 for 13443	66546.0
AE704	Pin Elast.6x50 Din 1481 for 13443	00267.4	38115	Sealing Rubber for 13443	14337.5	AM614	Wago Splicing Connector 2x0.25-4mm2 for 13443	67178.9
38113	PFS Sex UNC1 4x1.1 4 RTZB for 13443	00409.0	30222	Washer 2 78x7x20x25mm for 13443	15093.2	AN200	Nylon Washer 30x22x4.5mm for 13443	69406.1
30350	Nylon Cover CN-4472 for 13443	02031.1	AR260	CS Door GR. for 13443	16961.7	AP195	Wiring Harness Compl. for 13443	69498.4
16403	Washer L 3/8 Stainless Steel for 13443	03213.1	78572	Plug Sext.M32 Black for 13443	17698.2	AN201	10A C-Curved Monopolar Mini Circuit Breaker for 13443	69943.9

Electrical Schematics

Model PE-BR-0010 13443

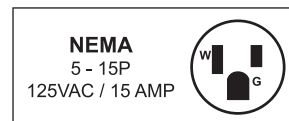
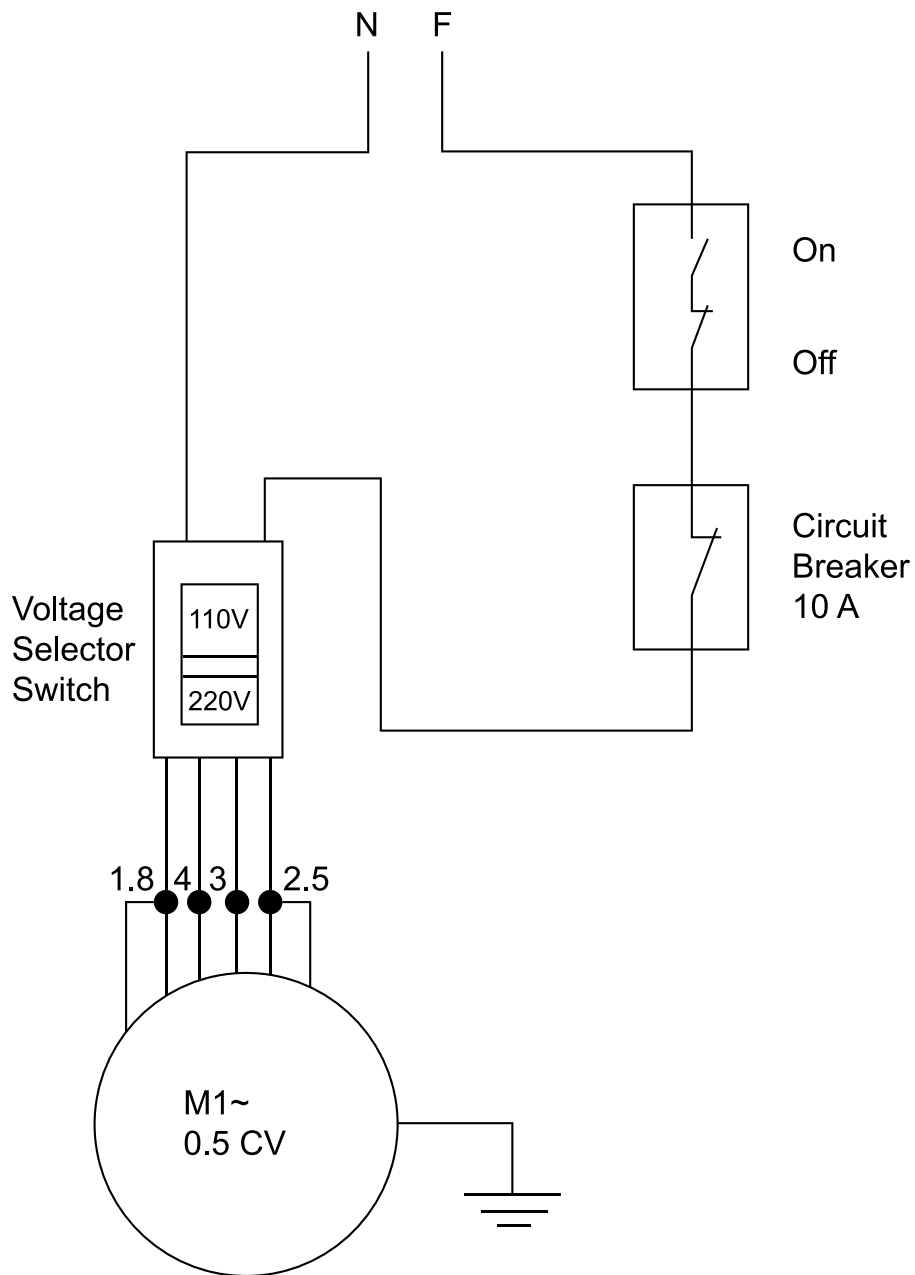



Warranty Registration

Thank you for purchasing an Omcan product. To register your warranty for this product, complete the information below, tear off the card at the perforation and then send to the address specified below. You can also register online by visiting:

Merci d'avoir acheté un produit Omcan. Pour enregistrer votre garantie pour ce produit, complétez les informations ci-dessous, détachez la carte au niveau de la perforation, puis l'envoyer à l'adresse spécifiée ci-dessous. Vous pouvez également vous inscrire en ligne en visitant:

Gracias por comprar un producto Omcan usted. Para registrar su garantía para este producto, complete la información a continuación, cortar la tarjeta en la perforación y luego enviarlo a la dirección indicada a continuación. También puede registrarse en línea en:

<https://omcan.com/warranty-registration/>

For mailing in Canada

Pour postale au Canada

Por correo en Canadá

OMCAN

PRODUCT WARRANTY REGISTRATION

3115 Pepper Mill Court,
Mississauga, Ontario
Canada, L5L 4X5

For mailing in the US

Pour diffusion aux États-Unis

Por correo en los EE.UU.

OMCAN

PRODUCT WARRANTY REGISTRATION

4450 Witmer Industrial Estates, Unit 4,
Niagara Falls, New York
USA, 14305

or email to: service@omcan.com



Purchaser's Information

Name: _____

Address: _____

City: _____ Province or State: _____ Postal or Zip: _____

Country: _____

Dealer from which Purchased: _____

Dealer City: _____ Dealer Province or State: _____

Invoice: _____

Model Name: _____ Model Number: _____

Machine Description: _____

Date of Purchase (MM/DD/YYYY): _____

Would you like to extend the warranty? Yes No

Company Name: _____

Telephone: _____

Email Address: _____

Type of Company:

Restaurant Bakery Deli

Butcher Supermarket Caterer

Institution (*specify*): _____

Other (*specify*): _____

Serial Number: _____

Date of Installation (MM/DD/YYYY): _____

Thank you for choosing Omcan | Merci d'avoir choisi Omcan | Gracias por elegir Omcan



Since 1951 Omcan has grown to become a leading distributor of equipment and supplies to the North American food service industry. Our success over these many years can be attributed to our commitment to strengthen and develop new and existing relationships with our valued customers and manufacturers. Today with partners in North America, Europe, Asia and South America, we continually work to improve and grow the company. We strive to offer customers exceptional value through our qualified local sales and service representatives who provide convenient access to over 6,500 globally sourced products.

Depuis 1951 Omcan a grandi pour devenir un des "leaders" de la distribution des équipements et matériel pour l'industrie des services alimentaires en Amérique du Nord. Notre succès au cours de ces nombreuses années peut être attribué à notre engagement à renforcer et à développer de nouvelles et existantes relations avec nos clients et les fabricants de valeur. Aujourd'hui avec des partenaires en Amérique du Nord, Europe, Asie et Amérique du Sud, nous travaillons continuellement à améliorer et développer l'entreprise. Nous nous efforçons d'offrir à nos clients une valeur exceptionnelle grâce à nos ventes locales qualifiées et des représentants de service qui offrent un accès facile à plus de 6500 produits provenant du monde entier.

Desde 1951 Omcan ha crecido hasta convertirse en un líder en la distribución de equipos y suministros de alimentos en América del Norte industria de servicios. Nuestro éxito en estos años se puede atribuir a nuestro compromiso de fortalecer y desarrollar nuevas relaciones existentes con nuestros valiosos clientes y fabricantes. Hoy con socios de América del Norte, Europa, Asia y América del Sur, que trabajan continuamente para mejorar y crecer la empresa. Nos esforzamos por ofrecer a nuestros clientes valor excepcional a través de nuestro local de ventas y representantes de los servicios que proporcionan un fácil acceso a más de 6,500 productos con origen a nivel mundial.

