



Vacuum Packaging Machines

Models VP-CN-0749, 1066, 0500

Items 19481, 19482, 44594

Instruction Manual



Revised - 10/04/2024



Toll Free: 1-800-465-0234
Fax: 905-607-0234
Email: service@omcan.com
www.omcan.com



Table of Contents

Model VP-CN-0749 / Model VP-CN-1066 / Model VP-CN-0500

Section	Page
General Information -----	3 - 4
Safety and Warranty -----	4 - 5
Technical Specifications -----	6
Installation -----	6 - 7
Operation -----	7 - 8
Maintenance -----	9 - 12
Troubleshooting -----	13
Parts Breakdown -----	14 - 17
Electrical Schematics -----	18
Warranty Registration -----	19



General Information

Omcan Manufacturing and Distributing Company Inc., Food Machinery of America, Inc. dba Omcan and Omcan Inc. are not responsible for any harm or injury caused due to any person's improper or negligent use of this equipment. The product shall only be operated by someone over the age of 18, of sound mind, and not under the influence of any drugs or alcohol, who has been trained in the correct operation of this machine, and is wearing authorized, proper safety clothing. Any modification to the machine voids any warranty, and may cause harm to individuals using the machine or in the vicinity of the machine while in operation.

CHECK PACKAGE UPON ARRIVAL

Upon receipt of an Omcan shipment please inspect for external damage. If no damage is evident on the external packaging, open carton to ensure all ordered items are within the box, and there is no concealed damage to the machine. If the package has suffered rough handling, bumps or damage (visible or concealed), please note it on the bill of lading before accepting the delivery and contact Omcan within 24 hours, so we may initiate a claim with the carrier. A detailed report on the extent of the damage caused to the machine must be filled out within three days, from the delivery date shown in the shipping documents. Omcan has no recourse for damaged products that were shipped collect or third party.

Before operating any equipment, always read and familiarize yourself with all operation and safety instructions.

Omcan would like to thank you for purchasing this machine. It's of the utmost importance to save these instructions for future reference. Also save the original box and packaging for shipping the equipment if servicing or returning of the machine is required.

Omcan Fabrication et distribution Compagnie Limité et Food Machinery d'Amérique, dba Omcan et Omcan Inc. ne sont pas responsables de tout dommage ou blessure causé du fait que toute personne ait utilisé cet équipement de façon irrégulière. Le produit ne doit être exploité que par quelqu'un de plus de 18 ans, sain d'esprit, et pas sous l'influence d'une drogue ou d'alcool, qui a été formé pour utiliser cette machine correctement, et est vêtu de vêtements de sécurité appropriés. Toute modification de la machine annule toute garantie, et peut causer un préjudice à des personnes utilisant la machine ou des personnes à proximité de la machine pendant son fonctionnement.

VÉRIFIEZ LE COLIS DÈS RÉCEPTION

Dès réception d'une expédition d'Omcan veuillez inspecter pour dommages externes. Si aucun dommage n'est visible sur l'emballage externe, ouvrez le carton afin de s'assurer que tous les éléments commandés sont dans la boîte, et il n'y a aucun dommage dissimulé à la machine. Si le colis n'a subi aucune mauvaises manipulations, de bosses ou de dommages (visible ou cachée), notez-le sur le bond de livraison avant d'accepter la livraison et contactez Omcan dans les 24 heures qui suivent, pour que nous puissions engager une réclamation auprès du transporteur. Un rapport détaillé sur l'étendue des dommages causés à la machine doit être rempli dans un délai de trois jours, à compter de la date de livraison indiquée dans les documents d'expédition. Omcan n'a aucun droit de recours pour les produits endommagés qui ont été expédiés ou cueillis par un tiers transporteur.

Avant d'utiliser n'importe quel équipement, toujours lire et vous familiariser avec toutes les opérations et les

General Information

consignes de sécurité.

Omcan voudrais vous remercier d'avoir choisi cette machine. Il est primordial de conserver ces instructions pour une référence ultérieure. Également conservez la boîte originale et l'emballage pour l'expédition de l'équipement si l'entretien ou le retour de la machine est nécessaire.

Omcan Empresa De Fabricacion Y Distribucion Inc. Y Maquinaria De Alimentos De America, Inc. dba Omcan y Omcan Inc. no son responsables de ningun daño o perjuicio causado por cualquier persona inadecuada o el uso descuidado de este equipo. El producto solo podra ser operado por una persona mayor de 18 años, en su sano juicio y no bajo alguna influencia de droga o alcohol, y que este ha sido entrenado en el correcto funcionamiento de esta máquina, y ésta usando ropa apropiada y autorizada. Cualquier modificación a la máquina anula la garantía y puede causar daños a las personas usando la máquina mientras esta en el funcionamiento.

REVISE EL PAQUETE A SU LLEGADA

Tras la recepcion de un envio Omcan favor inspeccionar daños externos. Si no hay daños evidentes en el empaque exterior, Habra el carton para asegurarse que todos los articulos solicitados estén dentro de la caja y no encuentre daños ocultos en la máquina. Si el paquete ha sufrido un manejo de poco cuidado, golpes o daños (visible o oculto) por favor anote en la factura antes de aceptar la entrega y contacte Omcan dentro de las 24 horas, de modo que podamos iniciar una reclamación con la compañía. Un informe detallado sobre los daños causados a la máquina debe ser llenado en el plazo de tres días, desde la fecha de entrega que se muestra en los documentos de envío. Omcan no tiene ningun recurso por productos dañados que se enviaron a recoger por terceros.

Antes de utilizar cualquier equipo, siempre lea y familiarizarse con todas las instrucciones de funcionamiento y seguridad.

Omcan le gustaría darle las gracias por la compra de esta máquina. Es de la mayor importancia para salvar estas instrucciones para futuras consultas. Además, guarda la caja original y el embalaje para el envío del equipo si servicio técnico o devolución de la máquina que se requiere.

Safety and Warranty

GENERAL SAFETY REGULATIONS

These vacuum packaging machines are capable of: easy operation, easy maintenance, user friendly and also to cope with wide range application. Especially suitable for soft packing material such as complex film, aluminum-foil complex film etc. It can also pack products in vacuum form or inserting gas after vacuum form to solid, powder and even liquid, paste, seed, fragrant article, medicine, chemical, electronic, precision instrument, meter and rare expensive metal etc.

The machine must be used only by suitably trained personnel. Furthermore, this personnel must have read this



Safety and Warranty

manual carefully. In particular, please comply to the following instructions:

- This machine is user friendly. Close the machine cover, air exhaustion (vacuum), gas filling, heating, sealing, label printing, cooling, return-air, to the re-opening of cover, the whole processing is done automatically.
- The sealing temperature and sealing time can be set flexibly with a wide adjustable range so as to suit various packing bags with different materials and specifications.
- This machine is equipped with safe grounding protection and E-Stop button protection to deal with sudden accident. The E-Stop button can be pressed to stop packing procedure immediately if there is any emergency arise during processing.
- The articles packed in vacuum condition ensure to the quality and freshness for a longer period as it can prevent oxidation, mildew, moth, rotten and damp, vacuum machine have different working environment.

RESIDENTIAL USERS: vendor assumes no liability for parts or labor coverage for component failure or other damages resulting from installation in non-commercial or residential applications. The right is reserved to deny shipment for residential usage; if this occurs, you will be notified as soon as possible.

1 YEAR PARTS AND LABOR BENCH WARRANTY

Within the warranty period, contact Omcan Inc. at 1-800-465-0234 to schedule a drop off to either an Omcan authorized service depot in the area, or to an Omcan Service warehouse to repair the equipment.

Unauthorized maintenance will void the warranty. Warranty covers electrical and part failures, not improper use.

Please see <https://omcan.com/disclaimer> for complete info.

WARNING:

The packaging components are classified as normal solid urban waste and can therefore be disposed of without difficulty.

In any case, for suitable recycling, we suggest disposing of the products separately (differentiated waste) according to the current norms.

DO NOT DISCARD ANY PACKAGING MATERIALS IN THE ENVIRONMENT!

Technical Specifications

Model	VP-CN-0749	VP-CN-1066	VP-CN-0500
Item Number	19481	19482	44594
Power	0.5 HP / 0.37 kW	1.2 HP / 0.9 kW	1 HP / 0.75 kW
Seal Bar	10.2" x 0.3" / 259 x 8mm	15.4" x 0.3" / 391 x 8mm	20.5" x 0.3" / 520 x 8mm
Cycle Time	30 seconds	23 - 25 seconds	
Chamber Dimensions	15" x 11" x 3" 381 x 279 x 76mm	20" x 16" x 4" 508 x 406 x 102mm	21.3" x 20.5" x 7.9" 540 x 520 x 200mm
Electrical	110-120V / 60Hz / 1		
Weight	79.2 lbs. / 35.9 kgs.	96.8 lbs. / 43.9 kgs.	191.8 lbs. / 87 kgs.
Packaging Weight	96.8 lbs. / 43.9 kgs.	170 lbs. / 77.1 kgs.	233.7 lbs. / 106 kgs.
Dimensions	19" x 13" x 12.6" 483 x 330 x 320mm	24" x 18.5" x 20.5" 610 x 470 x 521mm	26.57" x 23.2" x 20" 675 x 589 x 508mm
Packaging Dimensions	22" x 17" x 15" 559 x 432 x 381mm	36" x 24" x 26" 914 x 610 x 660mm	29.52" x 25.9" x 22" 750 x 658 x 559mm

Omcans carries all size of vacuum packaging bags for the above models.

Installation

PREPARATION BEFORE USE

1. Before operation, please read through the user guide about each operation rule and safety precaution.
2. You must fill the vacuum pump with pump oil before use (when the machine is placed at a horizontal position, the oil should be kept at 1/3-1/2 in the oil window). When running, the oil level should not be lower than 1/3 in the oil window. Do not fill with too much oil to avoid overflow.
3. The machine should be placed horizontally in a well ventilated and lit space, free from corrosive gas and heavy dust.
4. Make sure that the machine is properly grounded before use.
5. Always ensure top cover is open before turning the power on. Start the machine by closing the top cover and the process will start automatically.
6. Preheat of vacuum pump must be done in low temperature working area. Turn off the heater selection switch at the control panel to off position. This is to prevent heating process and cut down wear and tear on the unit.

Tip: in order to quickly process a small item or product using a bigger chamber is to place a solid block into the chamber in order to occupy the chamber space so as to allow less vacuum time needed.

Note: do not block the air hole in the chamber.

Installation

SETTING

Please set every parameter first before starting the machine.

1. Turn on the power supply, check through the setting shows on the panel and make sure “----” must be shown after setting is done. Otherwise, operation of this machine cannot be function if the setting is not on this mode.
2. Press the setting button, the indicator lamp of vacuum lights to enter into the setting state of vacuum timing. Press the upward or downward key to increase or decrease vacuum time in the range of 0-99 seconds.
3. After the vacuum time is set, press the set key and the nitrogen filling indicator lamp lights to enter into the setting state of nitrogen filling. Press the upward or downward key to increase or decrease nitrogen filling time in the range of 0-99 seconds.

Note: some models of our machine do not have nitrogen filling function, so after setting the vacuum time, it enter sealing time directly.

4. Press the setting button, heating indicator lamp lights to enter into heating setting state. Press the upward or downward key to increase or decrease the heating sealing time in the range of 0-3.5 seconds. The time setting should be from low timing and gradually to higher timings.
5. After the heating time is set, press the set key again, cooling indicator lamp lights to enter into the setting state of cooling time in the range of 0-9.9 seconds.
6. After the cooling time is set, press the set key again to finish the parameter setting, and “Ed” is shown in panel.

Press the “temperature selection” set key to enter into temperature set state. Press the set key once, indicate one corresponding temperature value, and the lamp shows orange color; there are three selections such as “high temperature”, “middle temperature” and “low temperature”. For a special requirement, please contact the equipment manufacturer.

Operation

NEW TYPE INSTRUCTIONS

Turn on the power supply, long press the “SET” to enter the memory function, there will “P0” to “P9” showed on the screen which means enter the memory setting mode, each time the “SET” is pressed which means to switch the preset parameter template, select P0 parameter template long press the “SET” to enter the P0 parameter template, press the “SEALING TEMPERATURE” to switch the sealing temperature, after that press the “SET” to set the vacuum, sealing and cooling time. Press the “SET” to return to the standby state. The complete process of parameter preset.

OLD TYPE INSTRUCTIONS

1. Turn on the power supply and select a suitable vacuum packing bag for the product.
2. Set the processing parameter and select the sealing temperature. Please refer to the Installation section.

Operation

3. Place the vacuum bag at the chamber with the opening end on top of the sealing bar. Clamp it with the hook provided.
4. Close the acrylic cover and the machine will complete the processing procedure automatically.
5. During processing, the vacuum chamber will form a vacuum self-lock state, the whole heating and sealing procedure are completed in a vacuum environment, and the LED display on panel shows the flow process.
6. When the vacuum indicator on panel lights, the equipment is under vacuum state, the LED display shows the timing of vacuum time, and it will enter into the next work state automatically after the timing is finished.
7. When the nitrogen filling indicator on panel lights, the equipment is under filling state, the LED display shows the reverse timing of filling time, and it will enter into the next work state automatically after the reverse timing is finished.
8. When heating indicator lights, the equipment enters into heating work state, and the panel shows the reverse timing of heating. It will enter into cooling state automatically after the timing is finished.
9. According to time setting, the machine doesn't act when cooling, the panel shows "□□" till the reverse timing is finished, air is returned, the cover opens automatically, and the whole processing is finished. Then prepare the next cycle.
10. Press the E-Stop button for a sudden condition under processing state, the machine will go to return-air action automatically, the cover opens automatically after return-air action, so the processing ends.

NOTES:

- When setting the sealing time, please add 1.5 secs of more cooling to prevent the sealing bar from overheating (ex. sealing time is set for 1.5 secs so the cooling time would be 3 seconds.)
- Silicone rubber strip come with one side nerving and the other for letter and number inserting. It will have embossed effect on sealing surface.
- Please do not run the machine without any vacuum bag attach. Otherwise, the heating element will have higher wear and tear.
- Cut off the power supply and pull out external plug when no use.
- The vacuum gauge/meter reading may be different due to different area. At high altitudes, the data in vacuum meter goes down.
- Please adopt suitable cooling measure when processing is done in a high temperature occasion.
- Please use the vacuum bag whose material does not bring any poisonous gas in the sealing.
- The machine should be placed horizontally in the transportation, the inversion is not allowed. The transportation must be proceeded strictly according to the instructing marks on the shipping case.
- The machine should be stored in dry, ventilated, normal temperature place.
- Mind your head when the lid open, and avoid the lid striking your head.
- Please ask a professional to solve the problem. Do not do some repair works by yourself.
- The spare parts should match our machine in the replacement.

IMPORTANT INFORMATION ABOUT COOLING: THE COOLING TIME MUST BE SET AT LEAST 1 SECOND LONGER THAN THE SEALING TIME, FAILURE TO DO SO MAY RESULT IN A FIRE.

SEALING TAPE AND HEATING WIRE REPLACEMENT



1. Disconnect the cable from the pin, then pick the complete sealing bar up from the vacuum chamber.

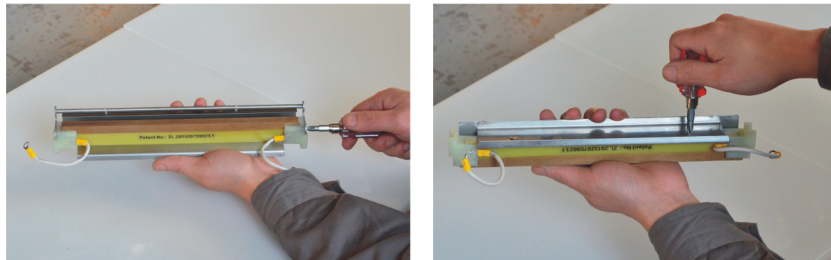

2. Remove the pressing stick from the complete sealing bar by cross screwdriver, then remove the stainless steel base (gas bag base).

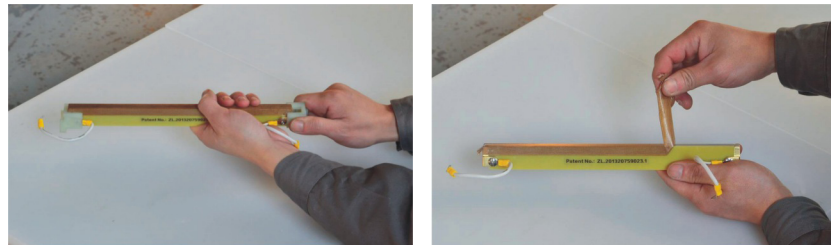

3. Pull the plastic parts out from the two sides of sealing bar by hand, then tear off the sealing tape.

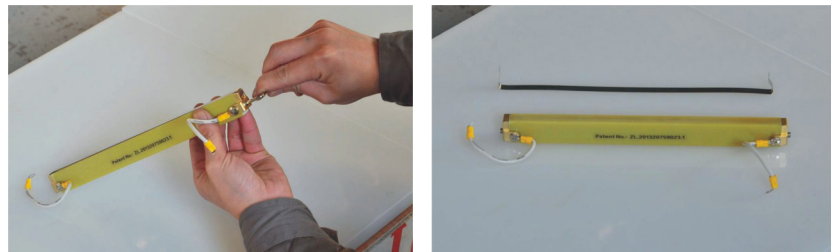

4. Remove the forcing screws from the two sides of sealing bar by Allen key, then take out the heating wire.

Maintenance

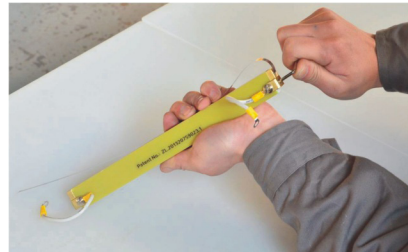

5. Put one side of a new heating wire into the fastener groove and tighten it by spanner.

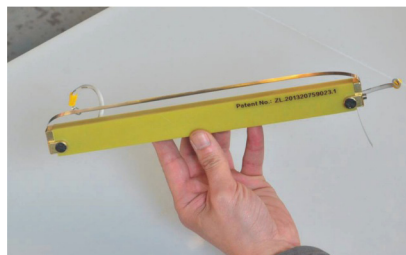

6. Put the other side of heating wire into another side fastener groove, then screw the remaining heating wire by the special tool.

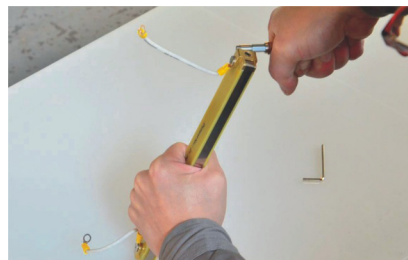
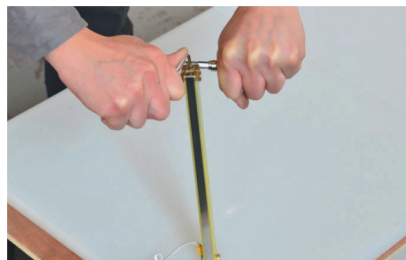

7. Fasten the heating wire by Allen key, then cut the remaining heating wire by the special tool.



8. Take a sealing tape at proper length and sticker it on the heating wire.



9. Cut the remaining sealing tape on the two sides enable to fold it.

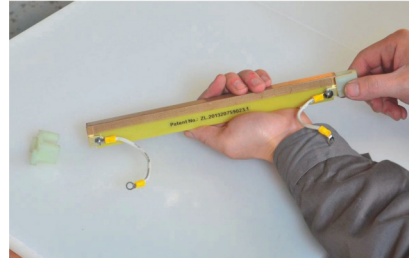

10. Put plastic parts on the two sides of sealing bar.

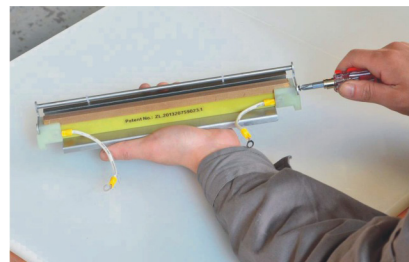
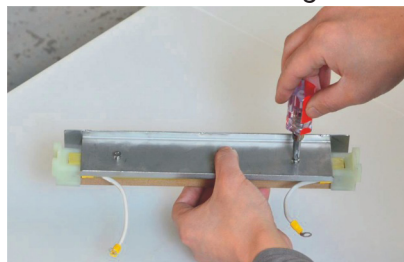

11. Install the stainless steel base and pressing stick.



12. Connect the cable of complete sealing bar to the pin, then put the sealing bar back to vacuum chamber to finish the installation.

FILLING THE OIL

Note: only perform this procedure on a flat, stable surface.

1. Unscrew the side board by removing both housing screws at the bottom middle of the side boards.
2. Lift the casing gently until the inside of the unit is revealed, ensure that the lid is carefully place on the work surface to prevent damage.

Maintenance

3. Check the oil level: if oil appears milky white it should be replaced.
- Ensure that the oil level is at least between 1/2 to 3/4 full. You must not exceed the amount of oil, you can damage the pump with adding too much oil.

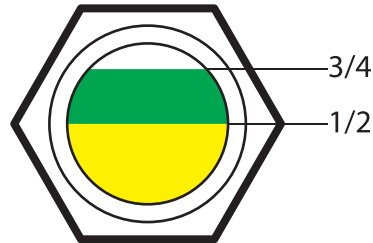

4. Unscrew the oil drain and remove the old oil.
5. Screw the oil drain back on, then unscrew the refueling cap and fill the oil to the necessary amount. Seal the cap.



6. Close the unit by following steps 1 and 2 in reverse order.

NOTES

- It is recommended to replace the oil every 120 hours.
- It is recommended to replace the oil when the vacuum pump is still warm from use.

Note: hydraulic oil to be used is Omcan item 15713.

Troubleshooting

Problem	Possible Solutions
Vacuum pump does not work.	Limit switch is not pressed on, close the machine cover and adjust the limit switch.
	Limit switch is broken, replace it.
	Contactor is broken, replace it.
	Pump motor is broken, replace it.
Vacuum chamber cannot reach the vacuum degree.	The vacuum pump is worn or damaged.
	Loose air pipe joint, broken pip, damaged sealing ring of vacuum chamber or damaged valve causes the entry of air into vacuum chamber.
	Insufficient oil in vacuum pump.
	Vacuum time is not enough.
Cover cannot be opened.	Air release valve is not turned on.
Air remains in bag after processing is finished.	Wrong position resting on seal bar.
	Pressing stick press the bag opening side causes the air cannot be sucked.
Abnormal sound or tripping when running, black smoke or oil drop.	Abnormal sound of fan of pump motor, it should be repaired.
	Blockage may be seen in air intake and/or pip.
	Insufficient oil of vacuum pump or the use of non-standard oil.
	Long time running of pump or overheat running under high temperature.
	Faulty vacuum pump motor or valve of vacuum pump or wear and tear due to usage.

Parts Breakdown

Model VP-CN-0749 19481

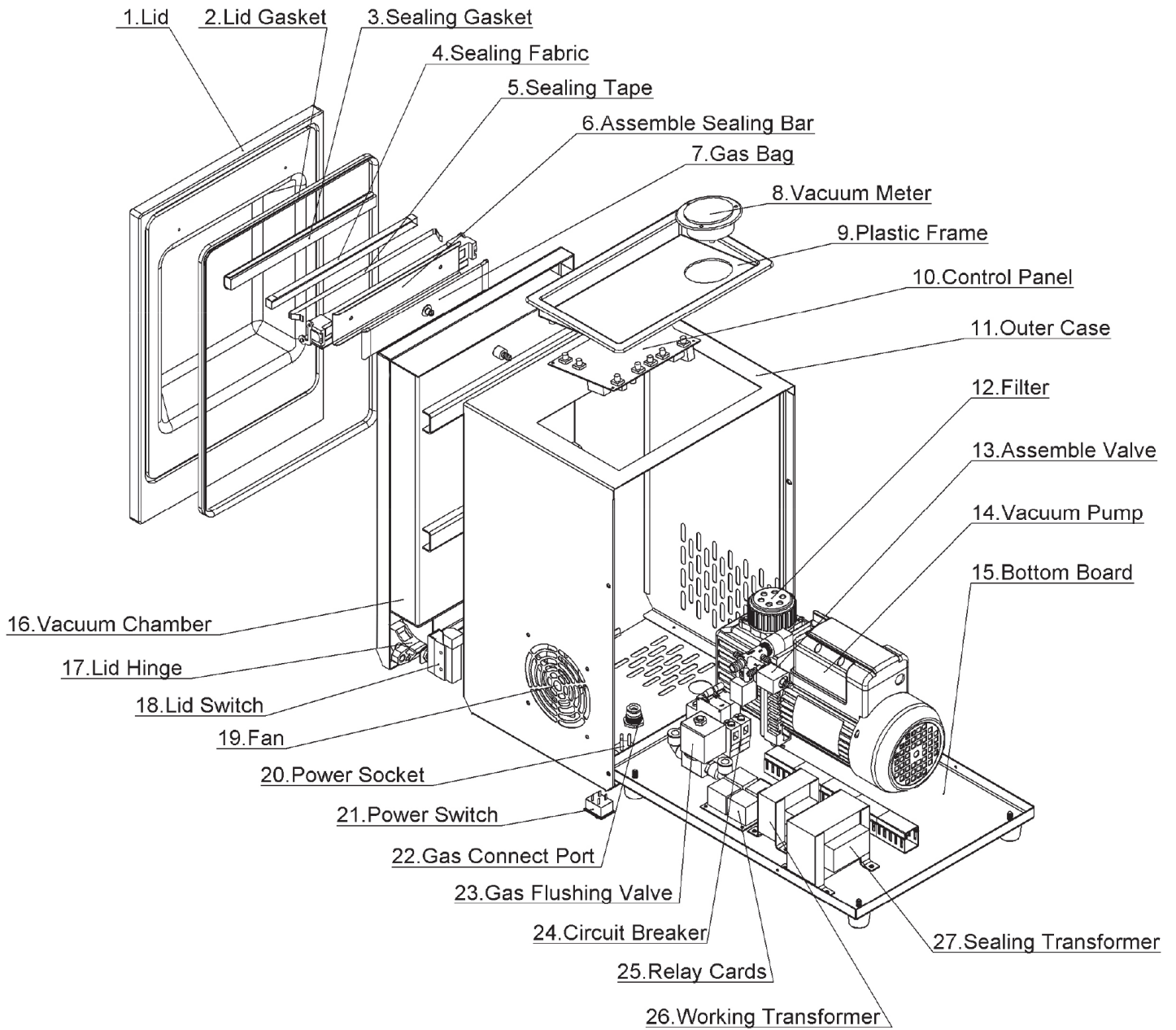

Parts Breakdown

Model VP-CN-0749 19481

Item No.	Description	Position	Item No.	Description	Position	Item No.	Description	Position
67581	Lid for 19481	1	67590	Control Panel for 19481	10	67597	Gas Connect Port for 19481	22
20835	Lid Gasket per Meter for 19481	2	67591	Filter for 19481	12	67600	Gas Flushing Valve for 19481	23
67583	Sealing Gasket for 19481	3	67592	Assemble Valve for 19481	13	67601	Circuit Breaker for 19481	24
67584	Sealing Fabric (10M/Roll) for 19481	4	67593	Vacuum Pump for 19481	14	67602	Relay Cards for 19481	25
20836	Sealing Tape (Teflon) per Meter for 19481	5	67594	Lid Hinge for 19481	17	67603	Working Transformer for 19481	26
14977	Complete Sealer for 19481	6	67595	Lid Switch for 19481	18	67604	Sealing Transformer for 19481	27
67587	Gas Bag for 19481	7	67596	Fan for 19481	19	67605	PP Plate for 19481	
67588	Vacuum Meter for 19481	8	67598	Power Socket for 19481	20			
67589	Plastic Frame for 19481	9	67599	Power Switch for 19481	21			

Parts Breakdown

Model VP-CN-1066 19482

Model VP-CN-0500 44594

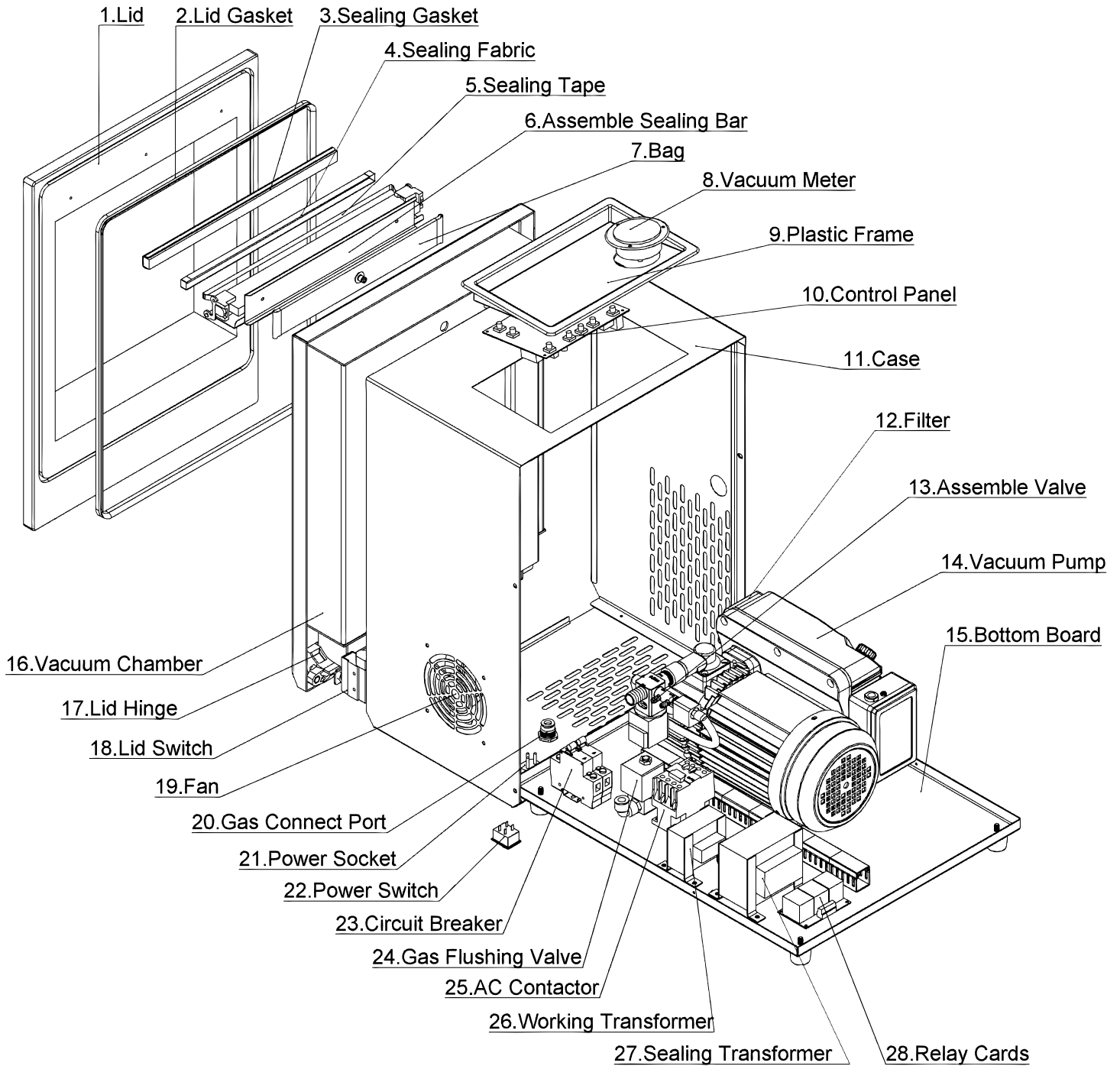

Parts Breakdown

Model VP-CN-1066 19482

Item No.	Description	Position	Item No.	Description	Position	Item No.	Description	Position
67606	Lid for 19482	1	67615	Control Panel for 19482	10	67624	Power Switch for 19482	22
20835	Lid Gasket per Meter for 19482	2	67616	Filter for 19482	12	67626	Circuit Breaker for 19482	23
67608	Sealing Gasket for 19482	3	67617	Assemble Valve for 19482	13	67625	Gas Flushing Valve for 19482	24
20836	Sealing Tape (Teflon) per Meter for 19482	4	67618	Vacuum Pump for 19482	14	67628	Working Transformer for 19482	26
20826	Sealing Wire (Metal) per Meter for 19482	5	67619	Lid Hinge for 19482	17	67629	Sealing Transformer for 19482	27
31290	Complete Sealer for 19482	6	67620	Lid Switch for 19482	18	67627	Relay Cards for 19482	28
67612	Gas Bag for 19482	7	67621	Fan for 19482	19	67630	PP Plate for 19482	
67613	Vacuum Meter for 19482	8	67622	Gas Connect Port for 19482	20			
67614	Plastic Frame for 19482	9	67623	Power Socket for 19482	21			

Model VP-CN-0500 44594

Item No.	Description	Position	Item No.	Description	Position	Item No.	Description	Position
69953	Lid for 44594	1	67590	Control Panel for 44594	10	67599	Power Switch for 44594	22
20835	Lid Gasket per Meter for 44594	2	69957	Filter for 44594	12	67601	Circuit Breaker for 44594	23
69954	Sealing Gasket for 44594	3	69958	Assemble Valve for 44594	13	67600	Gas Flushing Valve for 44594	24
67584	Sealing Fabric (10M/Roll) for 44594	4	69959	Vacuum Pump for 44594	14	69961	Working Transformer for 44594	26
20836	Sealing Tape (Teflon) per Meter for 44594	5	67594	Lid Hinge for 44594	17	69962	Sealing Transformer for 44594	27
69955	Assemble Sealing Bar for 44594	6	67595	Lid Switch for 44594	18	69963	Relay Cards for 44594	28
69956	Gas Bag for 44594	7	67596	Fan for 44594	19	69964	PP Plate for 44594	
67588	Vacuum Meter for 44594	8	67597	Gas Connect Port for 44594	20			
67589	Plastic Frame for 44594	9	67598	Power Socket for 44594	21			

Electrical Schematics

Model VP-CN-0749 19481

Model VP-CN-1066 19482

Model VP-CN-0500 44594

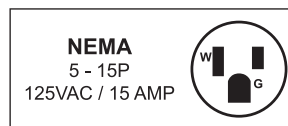
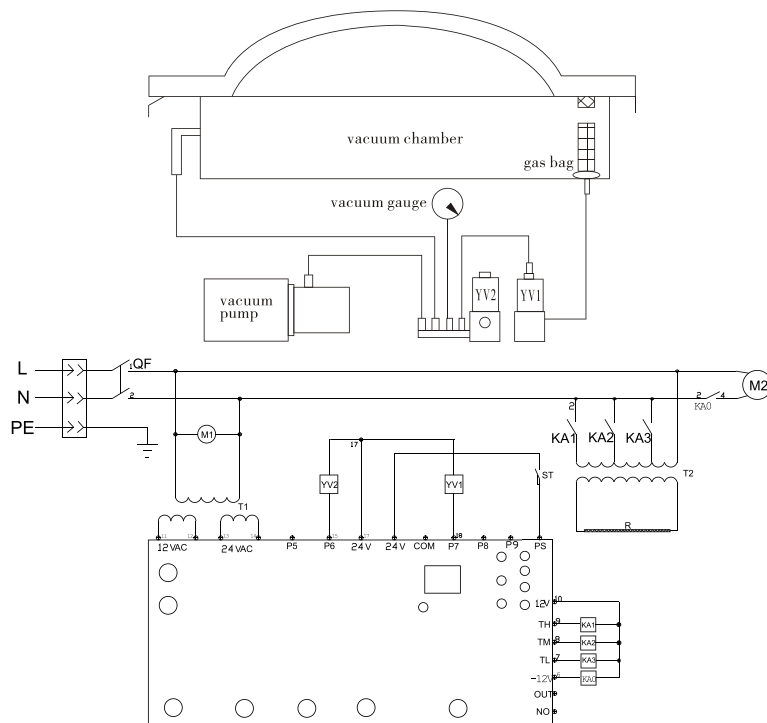

Code	Description	Code	Description
KA0~3	Four in one relay.	R	Heating wire (R1-2).
KA1~3	Three in one relay.	ST	Lid switch (travel switch).
KM	Contactora.	T1	Working transformer.
KM1	Contactora.	T2	Sealing transformer.
M1	Radiator fan.	YV1	Sealing valve.
M2	Pump motor.	YV2	Air release valve.
QF	Power switch.		



Warranty Registration

Thank you for purchasing an Omcan product. To register your warranty for this product, complete the information below, tear off the card at the perforation and then send to the address specified below. You can also register online by visiting:

Merci d'avoir acheté un produit Omcan. Pour enregistrer votre garantie pour ce produit, complétez les informations ci-dessous, détachez la carte au niveau de la perforation, puis l'envoyer à l'adresse spécifiée ci-dessous. Vous pouvez également vous inscrire en ligne en visitant:

Gracias por comprar un producto Omcan usted. Para registrar su garantía para este producto, complete la información a continuación, cortar la tarjeta en la perforación y luego enviarlo a la dirección indicada a continuación. También puede registrarse en línea en:

<https://omcan.com/warranty-registration/>

For mailing in Canada

Pour postale au Canada

Por correo en Canadá

OMCAN

PRODUCT WARRANTY REGISTRATION

3115 Pepper Mill Court,
Mississauga, Ontario
Canada, L5L 4X5

For mailing in the US

Pour diffusion aux États-Unis

Por correo en los EE.UU.

OMCAN

PRODUCT WARRANTY REGISTRATION

4450 Witmer Industrial Estates, Unit 4,
Niagara Falls, New York
USA, 14305

or email to: service@omcan.com



Purchaser's Information

Name: _____

Address: _____

City: _____ Province or State: _____ Postal or Zip: _____

Country: _____

Dealer from which Purchased: _____

Dealer City: _____ Dealer Province or State: _____

Invoice: _____

Model Name: _____ Model Number: _____

Machine Description: _____

Date of Purchase (MM/DD/YYYY): _____

Would you like to extend the warranty? Yes No

Company Name: _____

Telephone: _____

Email Address: _____

Type of Company:

Restaurant Bakery Deli

Butcher Supermarket Caterer

Institution (specify): _____

Other (specify): _____

Serial Number: _____

Date of Installation (MM/DD/YYYY): _____

Thank you for choosing Omcan | Merci d'avoir choisi Omcan | Gracias por elegir Omcan



Since 1951 Omcan has grown to become a leading distributor of equipment and supplies to the North American food service industry. Our success over these many years can be attributed to our commitment to strengthen and develop new and existing relationships with our valued customers and manufacturers. Today with partners in North America, Europe, Asia and South America, we continually work to improve and grow the company. We strive to offer customers exceptional value through our qualified local sales and service representatives who provide convenient access to over 6,500 globally sourced products.

Depuis 1951 Omcan a grandi pour devenir un des "leaders" de la distribution des équipements et matériel pour l'industrie des services alimentaires en Amérique du Nord. Notre succès au cours de ces nombreuses années peut être attribué à notre engagement à renforcer et à développer de nouvelles et existantes relations avec nos clients et les fabricants de valeur. Aujourd'hui avec des partenaires en Amérique du Nord, Europe, Asie et Amérique du Sud, nous travaillons continuellement à améliorer et développer l'entreprise. Nous nous efforçons d'offrir à nos clients une valeur exceptionnelle grâce à nos ventes locales qualifiées et des représentants de service qui offrent un accès facile à plus de 6500 produits provenant du monde entier.

Desde 1951 Omcan ha crecido hasta convertirse en un líder en la distribución de equipos y suministros de alimentos en América del Norte industria de servicios. Nuestro éxito en estos años se puede atribuir a nuestro compromiso de fortalecer y desarrollar nuevas relaciones existentes con nuestros valiosos clientes y fabricantes. Hoy con socios de América del Norte, Europa, Asia y América del Sur, que trabajan continuamente para mejorar y crecer la empresa. Nos esforzamos por ofrecer a nuestros clientes valor excepcional a través de nuestro local de ventas y representantes de los servicios que proporcionan un fácil acceso a más de 6,500 productos con origen a nivel mundial.

