

# INSTRUCTION MANUAL

## Band Saws

Item	45559	45506
Model	BS-IT-1524	BS-IT-1829-M



### Warning!

Before you begin using your appliance, **PLEASE READ AND UNDERSTAND THIS DOCUMENT CAREFULLY** before installing, operating, maintaining, or servicing.

There are many important safety messages in this manual and on your appliance. Always read all safety messages.

Failure to do so can result in appliance failure, property damage, serious injury or death. Appliance failure, injury or property damage due to improper installation is not covered by warranty.

### Stop!

**DO NOT RETURN THIS PRODUCT TO THE STORE!**

For questions or assistance with this product, call TRENTO Toll free: **1-800-465-0234** or visit the support section from our website, **www.trentoequipment.com**

Version: Revised - 03/15/2024



# TABLE OF CONTENTS

---

<b>Section</b>	<b>Section</b>
General Information -----	3 - 4
Safety and Warranty -----	4 - 7
Technical Specifications -----	8
Installation -----	8 - 12
Operation -----	12 - 13
Maintenance -----	13 - 14
Troubleshooting -----	15 - 17
Parts Breakdown -----	18 - 20
Electrical Schematics -----	21
Notes -----	22
Warranty Registration -----	23

## GENERAL INFORMATION

---

**Omcan Manufacturing and Distributing Company Inc., Food Machinery of America, Inc. dba Omcan and Omcan Inc. are not responsible for any harm or injury caused due to any person's improper or negligent use of this equipment. The product shall only be operated by someone over the age of 18, of sound mind, and not under the influence of any drugs or alcohol, who has been trained in the correct operation of this machine, and is wearing authorized, proper safety clothing. Any modification to the machine voids any warranty, and may cause harm to individuals using the machine or in the vicinity of the machine while in operation.**

### CHECK PACKAGE UPON ARRIVAL

Upon receipt of an Omcan shipment please inspect for external damage. If no damage is evident on the external packaging, open carton to ensure all ordered items are within the box, and there is no concealed damage to the machine. If the package has suffered rough handling, bumps or damage (visible or concealed), please note it on the bill of lading before accepting the delivery and contact Omcan within 24 hours, so we may initiate a claim with the carrier. A detailed report on the extent of the damage caused to the machine must be filled out within three days, from the delivery date shown in the shipping documents. Omcan has no recourse for damaged products that were shipped collect or third party.

**Before operating any equipment, always read and familiarize yourself with all operation and safety instructions.**

**Omcan would like to thank you for purchasing this machine. It's of the utmost importance to save these instructions for future reference. Also save the original box and packaging for shipping the equipment if servicing or returning of the machine is required.**

---

**Omcan Fabrication et distribution Compagnie Limitée et Food Machinery d'Amérique, dba Omcan et Omcan Inc. ne sont pas responsables de tout dommage ou blessure causé du fait que toute personne ait utilisé cet équipement de façon irrégulière. Le produit ne doit être exploité que par quelqu'un de plus de 18 ans, sain d'esprit, et pas sous l'influence d'une drogue ou d'alcool, qui a été formé pour utiliser cette machine correctement, et est vêtu de vêtements de sécurité appropriés. Toute modification de la machine annule toute garantie, et peut causer un préjudice à des personnes utilisant la machine ou des personnes à proximité de la machine pendant son fonctionnement.**

### VÉRIFIEZ LE COLIS DÈS RÉCEPTION

Dès réception d'une expédition d'Omcan veuillez inspecter pour dommages externes. Si aucun dommage n'est visible sur l'emballage externe, ouvrez le carton afin de s'assurer que tous les éléments commandés sont dans la boîte, et il n'y a aucun dommage dissimulé à la machine. Si le colis n'a subi aucune mauvaises manipulations, de bosses ou de dommages (visible ou cachée), notez-le sur le bond de livraison avant d'accepter la livraison et contactez Omcan dans les 24 heures qui suivent, pour que nous puissions engager une réclamation auprès du transporteur. Un rapport détaillé sur l'étendue des dommages causés à la machine doit être rempli dans un délai de trois jours, à compter de la date de livraison indiquée dans les documents d'expédition. Omcan n'a aucun droit de recours pour les produits endommagés qui ont été expédiés ou cueillis par un tiers transporteur.

**Avant d'utiliser n'importe quel équipement, toujours lire et vous familiariser avec toutes les opérations et les**

## GENERAL INFORMATION

---

consignes de sécurité.

Omcan voudrais vous remercier d'avoir choisi cette machine. Il est primordial de conserver ces instructions pour une référence ultérieure. Également conservez la boîte originale et l'emballage pour l'expédition de l'équipement si l'entretien ou le retour de la machine est nécessaire.

Omcan Empresa De Fabricacion Y Distribucion Inc. Y Maquinaria De Alimentos De America, Inc. dba Omcan y Omcan Inc. no son responsables de ningun daño o perjuicio causado por cualquier persona inadecuada o el uso descuidado de este equipo. El producto solo podra ser operado por una persona mayor de 18 años, en su sano juicio y no bajo alguna influencia de droga o alcohol, y que este ha sido entrenado en el correcto funcionamiento de esta máquina, y ésta usando ropa apropiada y autorizada. Cualquier modificación a la máquina anula la garantía y puede causar daños a las personas usando la máquina mientras esta en el funcionamiento.

### REVISE EL PAQUETE A SU LLEGADA

Tras la recepcion de un envio Omcan favor inspeccionar daños externos. Si no hay daños evidentes en el empaque exterior, Habra el carton para asegurarse que todos los articulos solicitados estén dentro de la caja y no encuentre daños ocultos en la máquina. Si el paquete ha sufrido un manejo de poco cuidado, golpes o daños (visible o oculto) por favor anote en la factura antes de aceptar la entrega y contacte Omcan dentro de las 24 horas, de modo que podamos iniciar una reclamación con la compañía. Un informe detallado sobre los daños causados a la máquina debe ser llenado en el plazo de tres días, desde la fecha de entrega que se muestra en los documentos de envío. Omcan no tiene ningun recurso por productos dañados que se enviaron a recoger por terceros.

**Antes de utilizar cualquier equipo, siempre lea y familiarizarse con todas las instrucciones de funcionamiento y seguridad.**

Omcan le gustaría darle las gracias por la compra de esta máquina. Es de la mayor importancia para salvar estas instrucciones para futuras consultas. Además, guarda la caja original y el embalaje para el envío del equipo si servicio técnico o devolución de la máquina que se requiere.

## SAFETY AND WARRANTY

---

**PERSONAL PROTECTIVE EQUIPMENT IN CONFORMITY WITH CURRENT RULES:** all the following personal protective equipment (PPE) has to be in conformity with relevant technical rules in force (directive no. 89/656/ CEE and following amendments and updates) and therefore has to be EC-marked and have relevant declaration of conformity which usually refers to specific European (EN) technical rules of the harmonized type. The operators must always inform the employer, manager and/or representative of the anomalies in the operation or characteristics of the use of their personal protective equipment.

**HEAD:** it is mandatory to use a cap to keep the hair gathered and to avoid entanglement within the moving

## SAFETY AND WARRANTY

---

elements; also for hygienic reasons, the cap must always be clean and must be able to retain all hair.

**EYES:** to protect the eyes from bone splinters or accidental blade breaking, the wearing of safety glasses is mandatory.

**NOSE, MOUTH:** to protect the respiratory tract from toxic emissions, pieces of meat or similar substances under processing, the operator must wear a filtering mask. It is also necessary to wear a filtering mask for hygienic reasons. The masks have to be replaced when they show signs of dirt or partial clogging or 2 (two) working days.

**EARS:** the machine does not produce a loud noise and according to the tests performed it produces a level of continuous acoustic pressure equivalent weighted "A" of 82 dB(A) ± 1 dB(A) vacuum and of 88 dB(A) ± 1 dB(A) in the dry cutting of bones particularly big and strong. Ear protectors (protective headset) are strongly recommended and workers must be instructed on their correct use. The use of new blades or very sharp blades and water-lubrication of the cutting area of bones contribute to reducing the noise. The duration of the noise, the characteristics of the buildings, and the noise of adjacent machines contribute to a louder noise. Submit workers to regular health checks.

**LIMBS AND BODY (what not to do):** never wear rings, wrist watches, bracelets, jewelry, torn dresses, loose clothing, scarves, ties, loose belts as they might get entangled and cause serious accidents.

**LIMBS AND BODY (what to do):** for the protection of the operator, always wear overalls or coats with elastic cuffs; both have to be worn tight, without leaving them open or just partially tight; tighten the sleeves around the cuffs and always keep your hair gathered in a cap.

**FEET:** it is mandatory to wear safety shoes with steel toes to protect the feet from the fall of heavy objects (the machine itself or its spare parts or big blocks of frozen food).

**HANDS:** to protect your hands, wear mesh protective gloves to replace the BLADES ONLY. **Make sure that the machine is off and power has been disconnected before changing the blades.**

The warranty can be exerted through the retailer (therefore it is exerted by Omcan) and:

- It always starts from the date when the machine is delivered by Omcan's authorized retailers and lasts for a maximum period of 12 (twelve) months.
- It guarantees the free replacement of the pieces which might break or abnormally wear due to assessed faults of design, supply, construction, or assembly which can be attributed to Omcan.
- The request for a free repair has to be directly addressed to Omcan or the dealer where the machine has been purchased.
- As for the repair (both free of charge and not), the machine has to be put in safe conditions (in the original packing or one similar to the original packaging), fully at the cost of the person requiring such repair. It must be sent to Omcan or those who have been authorized by the manufacturer to perform the repair (both free of charge and not).
- Possible faults in planning, supply, construction, assembly, appearance, functioning, training which can be attributed to Omcan have to notify Omcan by letter with return receipt and sent to the registered office. Omcan must be informed even by fax and/or e-mail in order to avoid further damage and/or accidents.

## SAFETY AND WARRANTY

---

- The non-fulfillment of these rules releases Omcan from the consequences of further damage and/or accidents subsequent to delayed or omitted communications.

### WARRANTY EXCLUSIONS

**WARNING!** The warranty of Omcan **NEVER INCLUDES:**

- The replacement of the machine after a service required for a failure.
- The reimbursement for the working hours used by staff not directly entrusted by Omcan to carry out services and/or repairs.
- The reimbursement for consumption, rent of equipment or purchase of equipment to carry out services and repairs by staff not directly entrusted by Omcan.
- The transportation of the machine to and from the authorized service center are fully at the cost of the person requiring repair.
- The necessary packaging to transport the repaired machine if it has been delivered without the original packing.
- The reimbursement for damaged or destroyed possessions or goods.
- The reimbursement for loss of profit, service interruption, expenses of any kind, penalties, or corporate image damage.
- The reimbursement for loss from other equipment, machines or manufacturing lines working together with this machine, subsequent to damage or destruction of things or goods in these equipment or machines or lines.
- Damage caused by the unsuitability of the environment where the machine is located (humidity, temperature, electromagnetic fields or dirt which exceed the limits established by this handbook and those established by law).
- Phenomena which do not depend on the normal functioning of the machine (atmospheric electric discharge, power stress, fire, flooding, etc.)
- Defects or failures caused by use not listed in this manual.
- Defects depending upon the wrong use of the machine by anyone and those defects which appear after changes carried out on the machine without the written authorization of Omcan.
- Defects and/or failures in case of non-original spare parts not having equivalent manufacturing characteristics.

### WARRANTY EXPIRATION

**WARNING!** The warranty of Omcan **COMPLETELY EXPIRES:**

- If any rule, instruction, recommendation, warning, prohibition listed by Omcan or their commercial network in any form (oral, written, by phone, fax or e-mail, on paper, electronic, magnetic, optical, audiovisual supports, etc.); or any rule in this handbook is infringed.
- With the improper or unreasonable use of the machine.
- If the machine is modified in any way, even slightly.
- If non-original spare parts or accessories of Omcan are assembled.
- If the machine is modified, without the written approval of Omcan, even if this would occur after recommendations or orders of public or private authorities for control and prevention.
- If the machine is repaired by staff who is not directly authorized by Omcan; inexperienced staff and unauthorized staff must not perform any repair or extraordinary maintenance.

## **SAFETY AND WARRANTY**

---

- If the damage to the machine is attributable to carelessness and negligence.
- If the machine has not been regularly purchased and paid according to contractual agreements existing with Omcan or with the authorized retailers.
- If there is no invoice or receipt proving the purchase.
- Any missed or delayed payment implies the expiry of the validity of the warranty granted by Omcan for the whole period of the missed or delayed payment.
- The periods relevant to the missed or delayed payment cannot be recovered after the settlement of the debt; the warranty of Omcan expires at this date.

**RESIDENTIAL USERS: vendor assumes no liability for parts or labor coverage for component failure or other damages resulting from installation in non-commercial or residential applications. The right is reserved to deny shipment for residential usage; if this occurs, you will be notified as soon as possible.**

### **1 YEAR PARTS AND LABOR BENCH WARRANTY**

**Within the warranty period, contact Omcan Inc. at 1-800-465-0234 to schedule a drop off to either an Omcan authorized service depot in the area, or to an Omcan Service warehouse to repair the equipment.**

**Unauthorized maintenance will void the warranty. Warranty covers electrical and part failures, not improper use.**

**Please see <https://omcan.com/disclaimer> for complete info.**

### **WARNING:**

The packaging components are classified as normal solid urban waste and can therefore be disposed of without difficulty.

**For suitable recycling, we suggest disposing of the products separately (differentiated waste) according to the local standards.**

**DO NOT DISCARD ANY PACKAGING MATERIALS IN THE ENVIRONMENT!**

## TECHNICAL SPECIFICATIONS

Item Number	45559	45506
Model	BS-IT-1524	BS-IT-1829-M
Blade Length	60" / 1520mm	72" / 1830mm
Cutting Capacity	7.5" x 7.3" / 190 x 185mm	10.6" x 8.3" / 270 x 210mm
Power	1.1 HP / 0.8 kW	1.2 HP / 0.9 kW
Electrical	110-120V / 60Hz / 1	
Current	12.5 A	
Weight	68.3 lbs. / 31 kgs.	71.7 lbs. / 32.5 kgs.
Packaging Weight	75.9 lbs. / 34 kgs.	81.6 lbs. / 37 kgs.
Dimensions (DWH)	16.9" x 18.1" x 28.7" 430 x 460 x 730mm	18.1" x 20.9" x 35" 460 x 530 x 890mm
Packaging Dimensions	31.5" x 17.7" x 15.7" 800 x 450 x 400mm	36.2" x 18.1" x 16.5" 920 x 460 x 420mm

## INSTALLATION

### INSTALLATION TO BE DONE BY LICENSED PROFESSIONALS ONLY.

A free space of at least 100 cm (39.37") has to be left around each side of the machine to decrease hazards of accidents resulting from the falling of the machine, difficulty in cleaning and maintenance, difficulty of use with large pieces of meat and similar big materials. The floor must be anti-slip and has to be always kept clean, especially from possible waste of the material being processed in order to avoid the operator slipping.

The machine has to be assembled on a very steady horizontal plane (or onto a very stable pedestal) having a height ranging from at least 45 cm (17.72") and not exceeding 69 cm (27.17") from ground so that the working table upper surface is at a height from the ground ranging from 80 cm (31.50") to 105 cm (41.34"). Then, the electrical assembly has to be carried out.

Do not touch the machine when connected to the feeding plug or the socket (110-120V ~ 60 Hz for single-phase motor machines).

- To switch the machine on, turn clockwise the rotational device towards "I" = ON = switched ON.
- To switch the machine off, turn counterclockwise the rotational device towards "O" = OFF = switched OFF.





## INSTALLATION

Check the correct rotation of the motor through the blade running direction, which always goes from upwards to downwards. Check that (both when the motor is running and when it is idle, but the machine is powered) the efficiency of the power supply and that the protection of the switchboard have been performed. If such checks are passed, the machine is electrically installed; if they are not, contact Omcan for assistance.

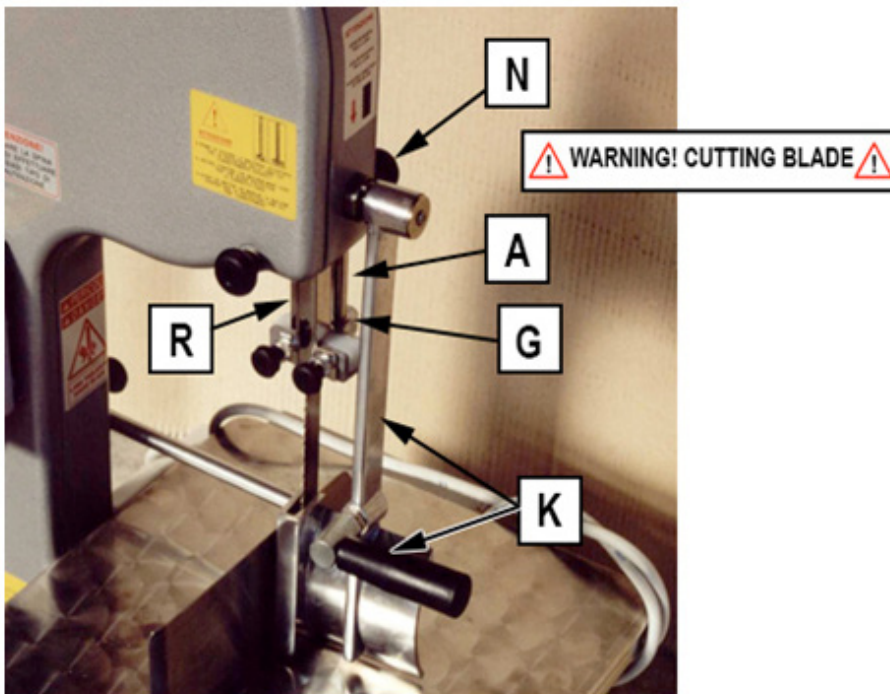
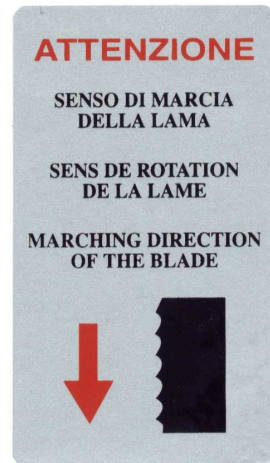

### BLADE GUIDE SLIDING BLOCKS ADJUSTMENT

1. Make sure that the machine is switched off (rotational device positioned "O" = OFF).
2. Make sure that the machine is not working (blade has stopped).

## INSTALLATION

---

3. Unscrew any of the two black (M) small knobs making sure not to unscrew it completely from its seat (S).
4. Bring the white sliding block (P) close to the blade (L) until they come very close.
5. Evaluate the thickness of the sliding block (the sliding blocks of the blade guide continuously wear; they have to be replaced when their thickness is below 1.5 cm) and, if necessary, replace it with a new sliding block.
6. Re-screw the small knob (M) up to lock the sliding block (P).
7. Repeat the operations from 1 to 6 for the other unit knob/sliding block.

**[K] OPTIONAL falling meat pusher.**

### BLADE GUIDE HEIGHT ADJUSTMENT

8. Make sure that the machine is switched off (rotational device positioned "O" = OFF).
9. Make sure that the machine is not working (blade has stopped).
10. Unscrew the black knob (N) (located opposite to the working table of the operator) which, through its integral screw, blocks the rod (A) of the blade guide (G) coming out from upper part of the machine and the working table; in this way, the rod (A) of the blade guide (G) can run vertically.
11. Adjust the height of the blade guide (G) according to the height of the material to cut (max. 1 cm above it).
12. Screw the small knob (N) to block the rod (A) of the blade guide (G), the blade guide (G) and the protection (R) is necessary to them, at the desired height.

**[K] OPTIONAL falling meat pusher.**

### BLADE TENSION ADJUSTMENT

13. Make sure that the machine is switched off (rotational device positioned "O" = OFF).
14. Make sure that the machine is not working (blade has stopped).
15. Screw the black knob (T) located on top to increase the blade tension and unscrew to decrease the blade tension; it is not necessary to open the door or unscrew the pulley to perform this adjustment.
16. Screw the black knob (T) so that the white line on the neck of the knob is very close to the frame of the bone band saw (as per photo of the back side of the bone band saw).
17. Always check the blade tension when the machine is not working before restarting it (before restarting the motor).

**(K) OPTIONAL falling meat pusher.**

## INSTALLATION

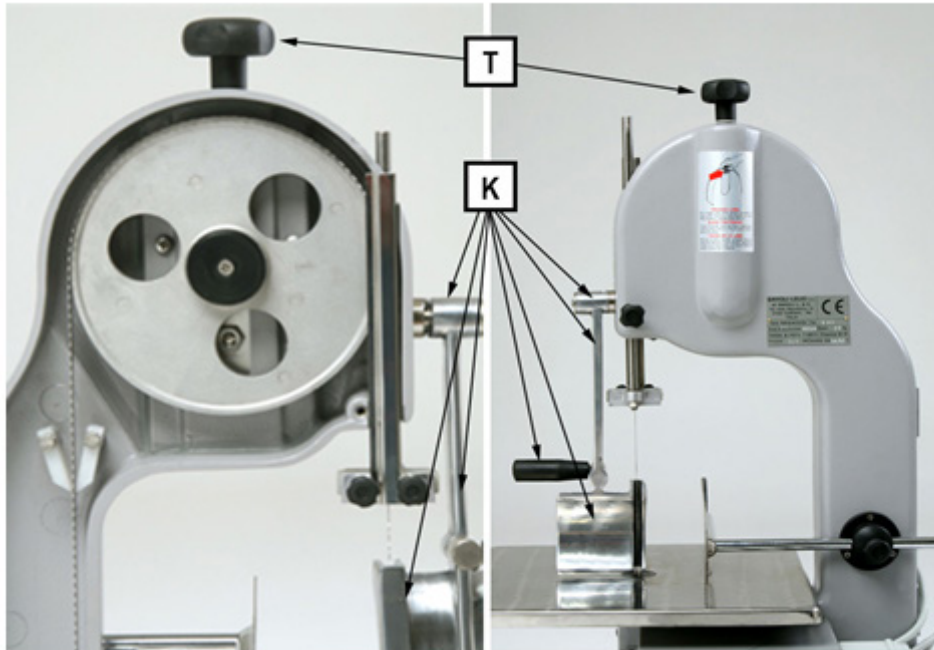

### BLADE REPLACEMENT

18. Make sure that the machine is switched off (rotational device positioned "0" = OFF).
19. Make sure that the machine is not working (blade has stopped).
20. Open the door (H) at least 90°.
21. Disassemble the protection device (R) from the blade necessary to the blade guide (G).
22. Unscrew the black knob (T) located on the top to decrease the interaxle between the two pulleys and reduce the tension of the blade until it easily and manually comes out from pulleys.
23. Extract the blade from the pulleys making sure not to hurt yourself (do not work bare hands, use the prescribed protective gloves) and put it in a safe place not accessible to children and non-trained personnel.
24. Insert a new blade in the pulleys making sure not to hurt yourself (do not work bare hands, but use the prescribed protective gloves) inserting it in the pulleys by shifting it as opposed to those performed to drawing it out.
25. Check the correct positioning of the new blade on the two pulleys.
26. Screw the black knob located on the top to increase the interaxle between the two pulleys and therefore increase the tension of the blade up to the desired value and in any case the blade cannot be manually extracted from the pulleys.
27. Re-assemble and adjust the protection device (R) of the blade integral to the blade guide.
28. Close the door (H) towards the framework body (C).

## INSTALLATION

---

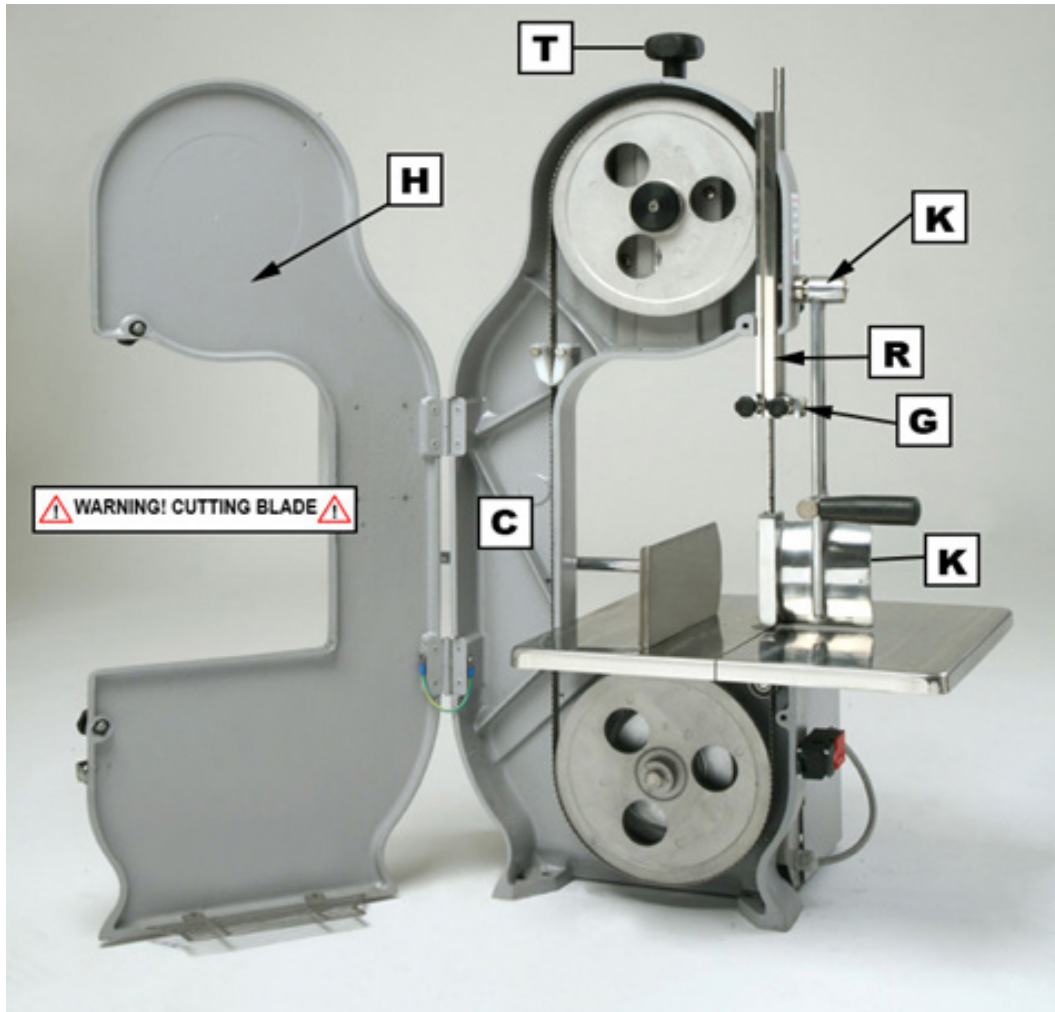

## OPERATION

---

1. Make sure that the machine is switched off (rotational device positioned "0" = OFF).
2. Make sure that the machine is not working (blade has stopped).
3. Put the material to cut on the working table.
4. Adjust the height of the blade guide according to the height of the material to cut.
5. Adjust the lateral position and leave a space similar to the thickness of the slice of product between it and the saw blade.
6. Bring the material to cut in contact with the device.
7. It is forbidden to cut materials such as wood, plastic, paving tiles, bricks, stones, glass, metals, leather, cardboard, fabrics, etc. even though a specific blade for this aim is available.
8. To cut other slices having the same thickness, repeat step 6 onward.

## OPERATION

---

9. To cut other slices having a different thickness, repeat step 5 onward.
10. If the height of the material to cut varies of more than 1 cm when cutting more slices, go back to 1.



### CUTTING FROZEN PRODUCT

These machines can be used to cut frozen product by following the below recommendations:

- To cut frozen fish, we recommend to use a saw blade of 20 mm width and 3 teeth per inch.
- To cut frozen bones, we recommend to use a saw blade of 20 mm width and 4 teeth per inch.

Additional blades can be purchased from Omcan.

## MAINTENANCE

---

**WARNING!** Before any cleaning and/or maintenance and/or check, switch the machine off (rotational device positioned "O" = OFF) and then disconnect the power cord from the socket. Cleaning, maintenance or check, no exceptions, have to be performed when the machine is not connected to the power supply.

Before restarting the machine, make sure that no one is touching it. The use and the regular cleaning of the machine will reduce the need for extraordinary maintenance and repair; the daily cleaning of the machine is an important factor to promptly detect possible defects or damages. At least once a week, clean the machine with a soft, dry cloth which does not lose its fabric on the rubbed surfaces. Avoid using petrol, solvents and any other type of detergent on the non-metallic parts which can be exclusively cleaned with a neutral and non-foamy water-based detergent. Never use abrasive products, chlorate substances, wire wools, brushes of any type, scrapers, etc., only use small brushes having sufficiently rigid bristles and cloths which do not lose fabrics, fibers or fragments.



## MAINTENANCE

---

**WARNING!** The machine must never be washed with pressurized water jets.

**WARNING!** The machine does not need lubrication or greasing since it is equipped with self-lubricating bearings.

**WARNING!** After a thorough visual check at the beginning of each shift, pay attention to:

- The cleanness inside the machine while paying special attention to the areas close to the pulleys; if necessary, clean and sanitize them.
- The cleanness of the lower container gathering the processed waste; if necessary, clean and sanitize it.
- The condition of the power cable located outside the machine body.
- The condition of the switchboard and the control buttons (check whether there are cracks, splintering, scratches, distortions, cuts, etc.).
- The working of all safety devices: the rotational device positioned "O" = OFF and door interblock microswitch; then all the remaining safety devices already listed.

If damaged or bad working components are detected, do not allow staff to use the machine and put a warning about the prohibition on it; then contact the dealer or Omcan for maintenance.

## STORAGE AND DISPOSAL

In order to preserve the machine for a very long period when switched off the following rules must be abided by:

- Disconnect the power cable from the socket.
- Do not lay objects on the machine and make sure that the place of storage is dry, not humid, dust-free, clean and free from insects or other animals and protected against bad weather conditions or other agents (for example, atmospheric agents, drops of water or other liquids, pollution) which might damage it; the place must not be subject to considerable temperature ranges.
- Abide by the data of the machine technical specification indicated earlier in the operating handbook.
- If the original packing is still available, put the machine into it or cover it with a piece of cloth of nylon, cellophane, polyethylene or other material of suitable size and package it to avoid it being damaged due to falls or damaged by other materials which might enter into contact with it.

It is also forbidden to leave or scatter the machine or any of its parts in the environment. It is also forbidden to dispose it in the container for solid urban waste; if the machine is no longer used, deliver it to qualified disposal facilities or authorized dealers.

## TROUBLESHOOTING

PROBLEM	POSSIBLE CAUSES	SOLUTIONS
Machine does not start.	Lack of power from the electrical network.	Restore the supply of power from the electrical network.
	Electrical network's ON/OFF is in "O" position, OFF.	Turn the ON/OFF switch of the electrical network to "I" position, ON.
	Machine's ON/OFF switch in "O" position.	Turn the ON/OFF switch to "I" position.
	Damaged ON/OFF switch.	Contact the manufacturer to have the ON/OFF switch replaced and check the electrical parameters (V, A, cos $\Phi$ ).
Machine does not stop.	Machine ON/OFF switch in "I" position.	Turn the ON/OFF switch to "O" position.
	Damaged ON/OFF switch.	Turn the ON/OFF switch to "O" position and contact the manufacturer or dealer to have the ON/OFF switch repaired.
Door is open but the machine does not stop.	Damaged door safety microswitch.	Contact Omcan or the dealer to have the door safety microswitch replaced.

## TROUBLESHOOTING

The machine is noisy (vibration, creaking, whistling, etc.)	The working table or one of the supports which do not touch the ground.	Add some shims under the working table or adjust the supports so that they are all flat.
	One or two supports of the machine do not lay properly on the working table.	Adjust the machine supports so that all lay flat.
	Saw blade is too slow or too tight.	Check the pulleys and the tension of the feeding band and adjust it through the upper black knobs.
	One or both pulleys are damaged or out of their axis.	Check the condition of the pulleys and if they are out of axis or not properly fixed, contact Omcan or the dealer to have them repaired.
	The door is not properly closed.	Check door hinges and relevant locking screws and, if necessary, screw them in.
	The safety microswitch is not properly fixed.	Check the safety microswitch locking screws and, if necessary, screw them.
	The sliding blocks of the blade guide are too tight on saw blade.	Adjust the sliding blocks slightly taking them away from the blade. See above on how to adjust the sliding blocks.
	Saw blade has damaged tothing.	Replace the saw blade with a new one. Ensure it is an original spare part.
	Saw blade with tothing unsuitable for the material to cut.	If the material to cut is among those envisaged for the machine, contact Omcan. or the dealer to have a saw blade suitable for the material to cut, otherwise read below.
	Material to cut is too hard.	Avoid trying to cut such material since it is not included in the list supplied by Omcan.
Material to cut is not included among those envisaged by Omcan.	Avoid trying to cut such material since it is not included in the list supplied by Omcan.	



## TROUBLESHOOTING

The saw blade coming out from the pulleys.	Saw blade is too slow or too tight.	Check the pulleys and the tension of the feeding band and adjust it through the upper black knobs.
	One or both pulleys are damaged or out from their axis.	Check the pulleys and contact Omcan or the dealer to have them repaired if they are out of their axis.
	Bad quality of the blade.	Replace the saw blade with a new one. Ensure it is an original spare part.
Considerable heating of the saw blade.	Loss of sharpening of the saw blade.	Replace the saw blade with a new and original one.
	Waste clogged between blade and blade guide.	Disassembly and thoroughly clean the blade guide and then reassemble it.
	Bearings of one or both pulleys are damaged or blocked.	Contact Omcan or the dealer to replace the bearings.
Cutting is not perfect.	Saw blade is too slow or too tight.	Check the pulleys and the tension of the feeding band and adjust it through the upper black knob if it differs from the relevant values.
	Loss of sharpening of the saw blade.	Replace the saw blade with a new one. Ensure it is an original spare part.

# PARTS BREAKDOWN

ITEM	MODEL
45559	BS-IT-1524
45506	BS-IT-1829-M

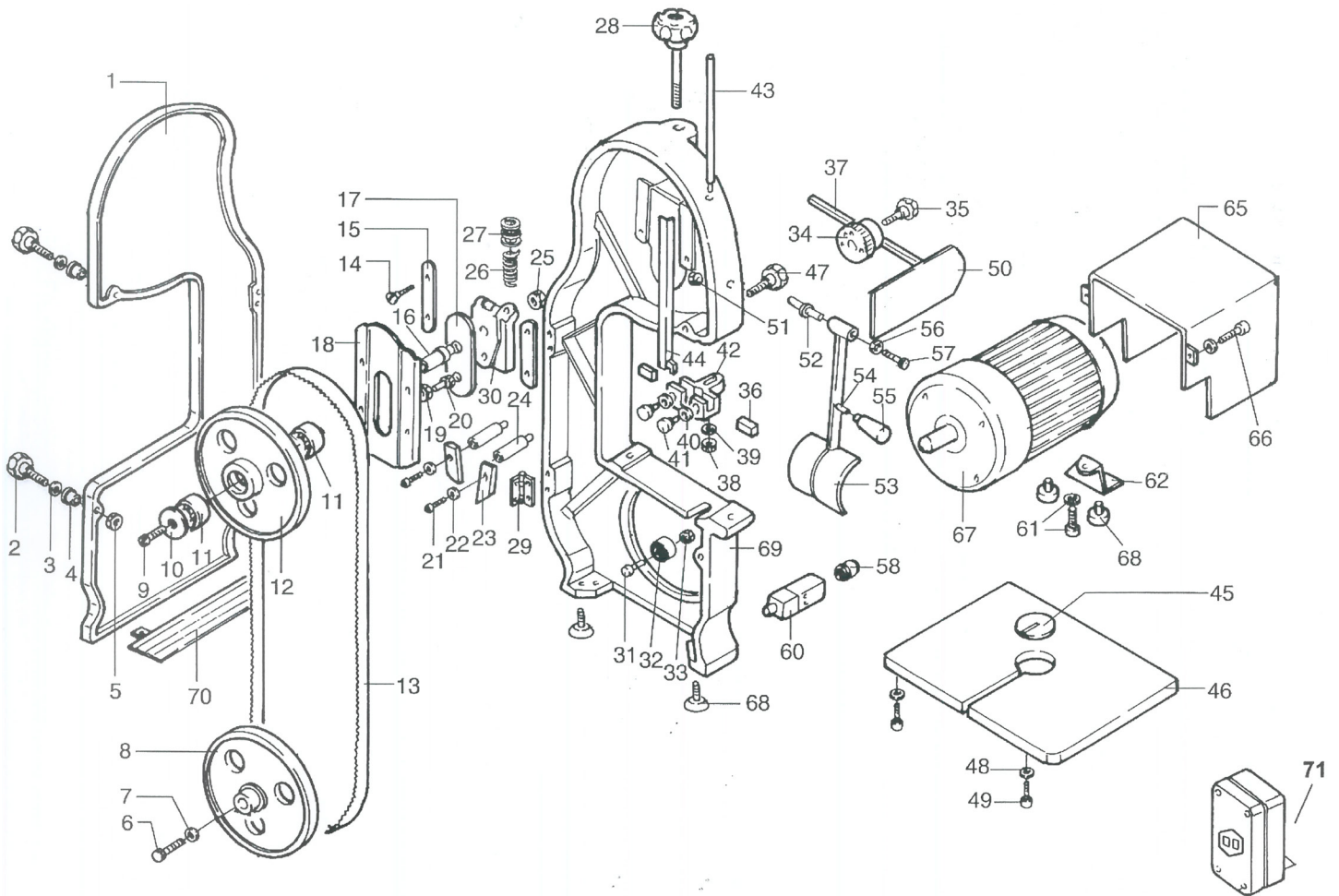

# PARTS BREAKDOWN

ITEM	MODEL
45559	BS-IT-1524

Item No.	Description	Position	Item No.	Description	Position
34880	Door for 45559	1	34898	Cutting Guide (Height 95mm) and Pole for 45559	37, 50
16445	Knob to Close the Opening Complete for 45559	2 - 5	34900	Nut and Washer for 45559	38, 39
34882	Lower Fly-Wheel Screw and Washer for 45559	6, 7	34901	Blade Guide Ring Nut in Aluminum for 45559	40
17777	Lower Fly-Wheel for 45559	8	34902	Blade Guide Knob for 45559	41
34885	Fly-Wheel and Screw to Protect from Dust for 45559	9, 10	17774	Blade Guide for 45559	42
34886	Bearing 6203 2RS for 45559	11	34903	Blade Guide Pole for 45559	43
34887	Upper Fly-Wheel for 45559	12	17775	Blade Protection for 45559	44
10316	60 Band Saw Blade 322 for 45559	13	17853	Bakelite Plate for 45559	45
34888	Washer Support and Screw for 45559	14, 15	34906	Working Table 33cmx33cm for 45559	46, 48, 49
34889	Pivot Upper Fly-Wheel for 45559	16, 25	17772	Knob of the Blade Guide Pole for 45559	47
34890	Lamination for 45559	17	41245	Meat Pusher for 45559	51 - 57
34891	Tension Slide for 45559	18	34912	Microswitch for 45559	60
34892	Adjustment Fly-Wheel Screw and Nut for 45559	19, 20	AP823	Motor Support Screw + Washer + Nut for 45559	61
22052	Shavehook for 45559	21 - 23	AP824	Motor Support for 45559	62
34908	Shavehook Pivot for 45559	24	34913	Motor Cover for 45559	65
34894	Tension Grip Spring for 45559	26	AP825	Screw and Washer Case Cap Motor for 45559	66
34895	Tension Grip Bearing for 45559	27	17768	Motor Single-Phase for 45559	67
34896	Tension Grip Knob for 45559	28	20206	Rubber Foot for 45559	68
34897	Hinge for 45559	29	34909	Housing for 45559	69
34893	Slide for 45559	30	AP826	Lower Guard for 45559	70
17770	Pivot and Bearing for 45559	31 - 33	44776	New Style Rotary Switch and Safety Relay and Box for 45559	71
17771	Cutting Guide Support and Knob for 45559	34, 35	34911	Plug for 45559	
16447	Blade Guide Insert for 45559	36			

# PARTS BREAKDOWN

ITEM	MODEL
45506	BS-IT-1829-M

Item No.	Description	Position	Item No.	Description	Position
34880	Painted Door for 45506	1	34898	Cutting Guide (Height 95mm) and Pole for 45506	37, 50
16445	Knob to Close the Opening Complete for 45506	2 - 5	34900	Nut and Washer for 45506	38, 39
34882	Lower Fly-Wheel Screw and Washer for 45506	6, 7	34901	Blade Guide Ring Nut in Aluminum for 45506	40
17777	Lower Fly-Wheel for 45506	8	34902	Blade Guide Knob for 45506	41
34885	Fly-Wheel and Screw to Protect from Dust for 45506	9, 10	17774	Blade Guide for 45506	42
34886	Bearing 6203 2RS for 45506	11	34903	Blade Guide Pole for 45506	43
34887	Upper Fly-Wheel for 45506	12	17775	Blade Protection for 45506	44
10316	60 Band Saw Blade 322 for 45506	13	17853	Bakelite Plate for 45506	45
34888	Washer Support and Screw for 45506	14, 15	34906	Working Table 33cmx33cm for 45506	46, 48 - 49
34889	Pivot Upper Fly-Wheel for 45506	16, 25	17772	Knob of the Blade Guide Pole for 45506	47
34890	Lamination for 45506	17	41245	Meat Pusher for 45506	51 - 57
34891	Tension Slide for 45506	18	34976	Cable Closer PG 11 for 45506	58
34892	Adjustment Fly-Wheel Screw and Nut for 45506	19, 20	34912	Microswitch for 45506	60
22052	Shavehook for 45506	21 - 23	AP823	Motor Support Screw + Washer + Nut (n° 2) for 45506	61
34908	Shavehook Pivot for 45506	24	AP824	Motor Support for 45506	62
34894	Tension Grip Spring for 45506	26	34914	Motor Cover for 45506	65
34895	Tension Grip Bearing for 45506	27	AP825	Screw and Washer Case Cap Motor (n° 4) for 45506	66
34896	Tension Grip Knob for 45506	28	17768	Motor Single-Phase for 45506	67
34897	Hinge for 45506	29	20206	Rubber Foot for 45506	68
34893	Slide for 45506	30	34909	Housing for 45506	69
17770	Pivot and Bearing for 45506	31 - 33	AP826	Lower Guard for 45506	70
17771	Cutting Guide Support and Knob for 45506	34, 35	44776	New Style Rotary Switch and Safety Relay and Box for 45506	71
16447	Blade Guide Insert for 45506	36	34911	Plug for 45506	

# ELECTRICAL SCHEMATICS

ITEM	MODEL
45559	BS-IT-1524
45506	BS-IT-1829-M

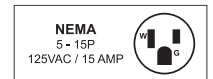
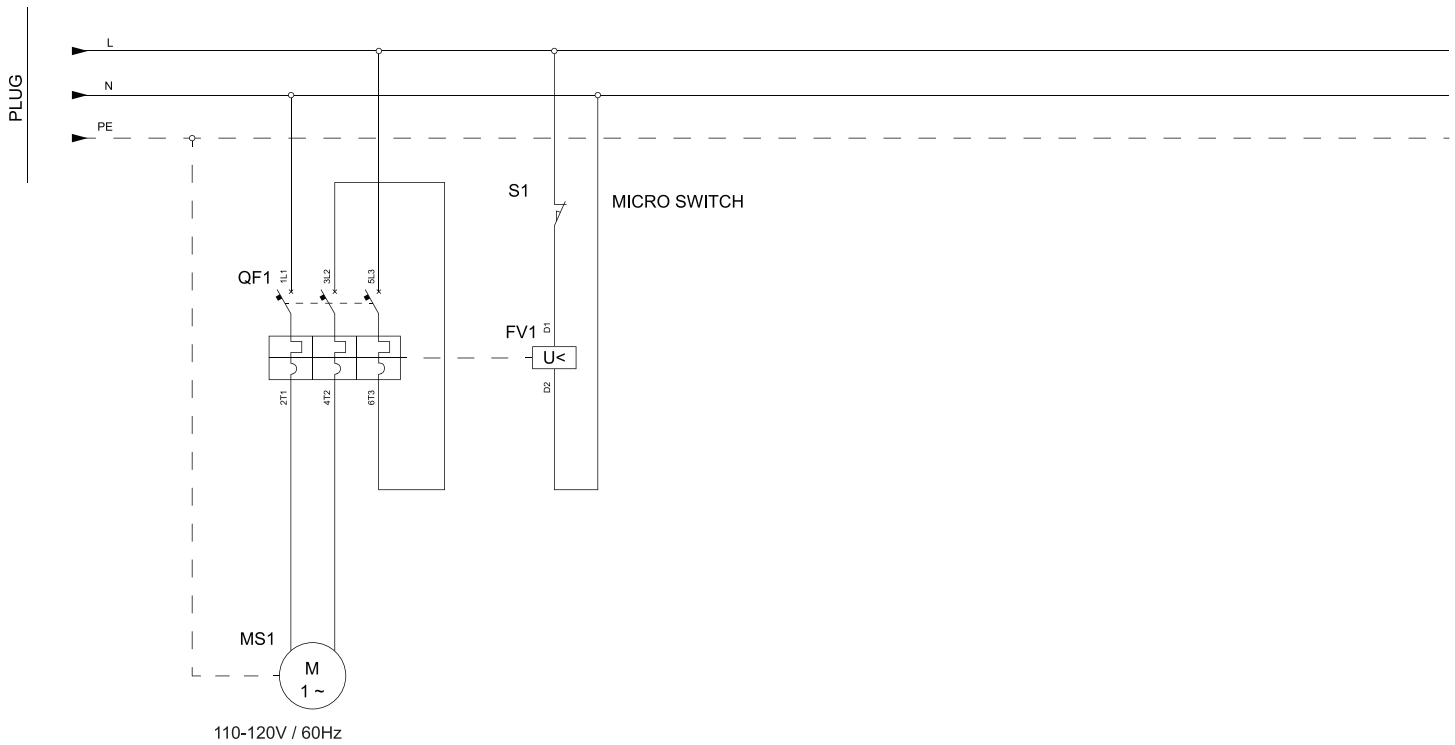



# WARRANTY REGISTRATION

Thank you for purchasing an Trento product. To register your warranty for this product, complete the information below, tear off the card at the perforation and then send to the address specified below. You can also register online by visiting:

Merci d'avoir acheté un produit Trento. Pour enregistrer votre garantie pour ce produit, complétez les informations ci-dessous, détachez la carte au niveau de la perforation, puis l'envoyer à l'adresse spécifiée ci-dessous. Vous pouvez également vous inscrire en ligne en visitant:

Gracias por comprar un producto Trento usted. Para registrar su garantía para este producto, complete la información a continuación, cortar la tarjeta en la perforación y luego enviarlo a la dirección indicada a continuación. También puede registrarse en línea en:

***<https://omcan.com/warranty-registration/>***

**For mailing in Canada**

**Pour postale au Canada**

**Por correo en Canadá**

**TRENTO**

PRODUCT WARRANTY REGISTRATION

3115 Pepper Mill Court,  
Mississauga, Ontario  
Canada, L5L 4X5

**For mailing in the US**

**Pour diffusion aux États-Unis**

**Por correo en los EE.UU.**

**TRENTO**

PRODUCT WARRANTY REGISTRATION

4450 Witmer Industrial Estates, Unit 4,  
Niagara Falls, New York  
USA, 14305

***or email to: [trentoservice@trentoequipment.com](mailto:trentoservice@trentoequipment.com)***



Purchaser's Information

Name: \_\_\_\_\_

Address: \_\_\_\_\_

City: \_\_\_\_\_ Province or State: \_\_\_\_\_ Postal or Zip: \_\_\_\_\_

Country: \_\_\_\_\_

Dealer from which Purchased: \_\_\_\_\_

Dealer City: \_\_\_\_\_ Dealer Province or State: \_\_\_\_\_

Invoice: \_\_\_\_\_

Model Name: \_\_\_\_\_ Model Number: \_\_\_\_\_

Machine Description: \_\_\_\_\_

Date of Purchase (MM/DD/YYYY): \_\_\_\_\_

Would you like to extend the warranty?  Yes  No

Company Name: \_\_\_\_\_

Telephone: \_\_\_\_\_

Email Address: \_\_\_\_\_

Type of Company:

Restaurant  Bakery  Deli

Butcher  Supermarket  Caterer

Institution (*specify*): \_\_\_\_\_

Other (*specify*): \_\_\_\_\_

Serial Number: \_\_\_\_\_

Date of Installation (MM/DD/YYYY): \_\_\_\_\_

**Thank you for choosing Trento | Merci d'avoir choisi Trento | Gracias por elegir Trento**

# TRENTO

ELEVATING CULINARY EXCELLENCE

TRENTO IS A SIGNATURE LINE OF PROFESSIONAL RESTAURANT EQUIPMENT FROM OMCAN OFFERING PREMIUM EUROPEAN BRANDS TO THE NORTH AMERICAN MARKET.

Thank you for your purchase!



Follow us on social media

@trentoequipment

