



Refrigerated Topping Rails

Models RS-CN-0009-PSS, 0006-PSS, 0004-PSS

Items 46497, 46657, 46658

Instruction Manual



Revised - 11/01/2024

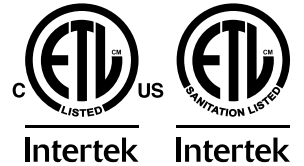

Toll Free: 1-800-465-0234
Fax: 905-607-0234
Email: service@omcan.com
www.omcan.com



Table of Contents

Model RS-CN-0009-PSS / Model RS-CN-0006-PSS
Model RS-CN-0004-PSS

Section	Page
Disclaimer -----	3
General Information -----	4 - 5
Safety and Warranty -----	5 - 7
Technical Specifications -----	8
Installation -----	8 - 9
Operation -----	9 - 13
Maintenance -----	13
Troubleshooting -----	14
Parts Breakdown -----	15 - 16
Electrical Schematics -----	17
Notes -----	18
Warranty Registration -----	19

OMCAN IS NOT RESPONSIBLE FOR ANY DAMAGES DUE TO WATER LEAKS. WARRANTY FOR WATER LEAKS IS VOID IF THE AMBIENT ROOM TEMPERATURE EXCEEDS 75°F AND 55% RELATIVE HUMIDITY, AND THE APPLIANCE DRAIN IS NOT CONNECTED DIRECTLY TO A FLOOR DRAIN.

OMCAN N'EST PAS RESPONSABLE DES DOMMAGES DUS AUX FUITES D'EAU. LA GARANTIE POUR LES FUITES D'EAU EST ANNULÉE SI LA TEMPÉRATURE AMBIANTE DE LA PIÈCE DÉPASSE 75°F ET 55% D'HUMIDITÉ RELATIVE, ET SI LE DRAIN DE L'APPAREIL N'EST PAS RACCORDÉ DIRECTEMENT À UN DRAIN DE PLANCHER.

OMCAN NO SE HACE RESPONSABLE DE LOS DAÑOS CAUSADOS POR FUGAS DE AGUA. LA GARANTÍA POR FUGAS DE AGUA QUEDA ANULADA SI LA TEMPERATURA AMBIENTE SUPERA LOS 75°F Y EL 55% DE HUMEDAD RELATIVA, Y EL DESAGÜE DEL APARATO NO ESTÁ CONECTADO DIRECTAMENTE A UN DESAGÜE DE PISO.

General Information

Omcan Manufacturing and Distributing Company Inc., Food Machinery of America, Inc. dba Omcan and Omcan Inc. are not responsible for any harm or injury caused due to any person's improper or negligent use of this equipment. The product shall only be operated by someone over the age of 18, of sound mind, and not under the influence of any drugs or alcohol, who has been trained in the correct operation of this machine, and is wearing authorized, proper safety clothing. Any modification to the machine voids any warranty, and may cause harm to individuals using the machine or in the vicinity of the machine while in operation.

CHECK PACKAGE UPON ARRIVAL

Upon receipt of an Omcan shipment please inspect for external damage. If no damage is evident on the external packaging, open carton to ensure all ordered items are within the box, and there is no concealed damage to the machine. If the package has suffered rough handling, bumps or damage (visible or concealed), please note it on the bill of lading before accepting the delivery and contact Omcan within 24 hours, so we may initiate a claim with the carrier. A detailed report on the extent of the damage caused to the machine must be filled out within three days, from the delivery date shown in the shipping documents. Omcan has no recourse for damaged products that were shipped collect or third party.

Before operating any equipment, always read and familiarize yourself with all operation and safety instructions.

Omcan would like to thank you for purchasing this machine. It's of the utmost importance to save these instructions for future reference. Also save the original box and packaging for shipping the equipment if servicing or returning of the machine is required.

Omcan Fabrication et distribution Compagnie Limité et Food Machinery d'Amérique, dba Omcan et Omcan Inc. ne sont pas responsables de tout dommage ou blessure causé du fait que toute personne ait utilisé cet équipement de façon irrégulière. Le produit ne doit être exploité que par quelqu'un de plus de 18 ans, sain d'esprit, et pas sous l'influence d'une drogue ou d'alcool, qui a été formé pour utiliser cette machine correctement, et est vêtu de vêtements de sécurité appropriés. Toute modification de la machine annule toute garantie, et peut causer un préjudice à des personnes utilisant la machine ou des personnes à proximité de la machine pendant son fonctionnement.

VÉRIFIEZ LE COLIS DÈS RÉCEPTION

Dès réception d'une expédition d'Omcan veuillez inspecter pour dommages externes. Si aucun dommage n'est visible sur l'emballage externe, ouvrez le carton afin de s'assurer que tous les éléments commandés sont dans la boîte, et il n'y a aucun dommage dissimulé à la machine. Si le colis n'a subi aucune mauvaises manipulations, de bosses ou de dommages (visible ou cachée), notez-le sur le bond de livraison avant d'accepter la livraison et contactez Omcan dans les 24 heures qui suivent, pour que nous puissions engager une réclamation auprès du transporteur. Un rapport détaillé sur l'étendue des dommages causés à la machine doit être rempli dans un délai de trois jours, à compter de la date de livraison indiquée dans les documents d'expédition. Omcan n'a aucun droit de recours pour les produits endommagés qui ont été expédiés ou cueillis par un tiers transporteur.

Avant d'utiliser n'importe quel équipement, toujours lire et vous familiariser avec toutes les opérations et les

General Information

consignes de sécurité.

Omcan voudrais vous remercier d'avoir choisi cette machine. Il est primordial de conserver ces instructions pour une référence ultérieure. Également conservez la boîte originale et l'emballage pour l'expédition de l'équipement si l'entretien ou le retour de la machine est nécessaire.

Omcan Empresa De Fabricacion Y Distribucion Inc. Y Maquinaria De Alimentos De America, Inc. dba Omcan y Omcan Inc. no son responsables de ningun daño o perjuicio causado por cualquier persona inadecuada o el uso descuidado de este equipo. El producto solo podra ser operado por una persona mayor de 18 años, en su sano juicio y no bajo alguna influencia de droga o alcohol, y que este ha sido entrenado en el correcto funcionamiento de esta máquina, y ésta usando ropa apropiada y autorizada. Cualquier modificación a la máquina anula la garantía y puede causar daños a las personas usando la máquina mientras esta en el funcionamiento.

REVISE EL PAQUETE A SU LLEGADA

Tras la recepcion de un envio Omcan favor inspeccionar daños externos. Si no hay daños evidentes en el empaque exterior, Habra el carton para asegurarse que todos los articulos solicitados estén dentro de la caja y no encuentre daños ocultos en la máquina. Si el paquete ha sufrido un manejo de poco cuidado, golpes o daños (visible o oculto) por favor anote en la factura antes de aceptar la entrega y contacte Omcan dentro de las 24 horas, de modo que podamos iniciar una reclamación con la compañía. Un informe detallado sobre los daños causados a la máquina debe ser llenado en el plazo de tres días, desde la fecha de entrega que se muestra en los documentos de envío. Omcan no tiene ningun recurso por productos dañados que se enviaron a recoger por terceros.

Antes de utilizar cualquier equipo, siempre lea y familiarizarse con todas las instrucciones de funcionamiento y seguridad.

Omcan le gustaría darle las gracias por la compra de esta máquina. Es de la mayor importancia para salvar estas instrucciones para futuras consultas. Además, guarda la caja original y el embalaje para el envío del equipo si servicio técnico o devolución de la máquina que se requiere.

Safety and Warranty

Please pay close attention to the safety notices in this section. Disregarding these notices may lead to serious injury and/or damage to the unit.

ATTENTION

- To minimize shock and fire hazards, be sure not to overload outlet. Please designate one outlet for your unit.
- Do not use extension cords.
- When the unit is not in use for a long period of time, please unplug the unit from the outlet.

Safety and Warranty

- After unplugging the unit, wait at least 10 minutes before plugging it back in. Failure to do so could cause damage to the compressor.

UNPLUG CORD

- To minimize shock and fire hazards, please do not plug or unplug the cord with wet hands.
- During maintenance and cleaning, please unplug the unit.

PROPER GROUNDING REQUIRED

- To minimize shock and fire hazards, make sure that the unit is properly grounded.

WARNING

- Do not attempt to remove or repair any component unless instructed by factory.
- Make sure that the unit is not resting on or against the electrical cord and plug.
- To minimize personal injury, do not hang on the doors.
- Do not store any flammable and explosive gas or liquids inside the unit.
- Do not attempt to alter or tamper with the electrical cord.

DANGER – RISK OF FIRE OR EXPLOSION. FLAMMABLE REFRIGERANT USED. TO BE REPAIRED ONLY BY TRAINED SERVICE PERSONNEL. DO NOT PUNCTURE REFRIGERANT TUBING.

CAUTION – RISK OF FIRE OR EXPLOSION. FLAMMABLE REFRIGERANT USED. CONSULT REPAIR MANUAL/ OWNER'S GUIDE BEFORE ATTEMPTING TO SERVICE THIS PRODUCT. ALL SAFETY PRECAUTIONS MUST BE FOLLOWED.

CAUTION – RISK OF FIRE OR EXPLOSION DUE TO PUNCTURE OF REFRIGERANT TUBING; FOLLOW HANDLING INSTRUCTIONS CAREFULLY. FLAMMABLE REFRIGERANT USED.

CAUTION – RISK OF FIRE OR EXPLOSION DUE TO FLAMMABLE REFRIGERANT USED. FOLLOW HANDLING INSTRUCTIONS CAREFULLY IN COMPLIANCE WITH LOCAL GOVERNMENT REGULATIONS.

IMPORTANT!!! PLEASE READ BEFORE INSTALLATION

- If the unit has recently been transported on its side, please let unit stand still for a minimum of 24 hours before plugging it in.
- Make sure that the unit drops down to desired temperature before loading the unit with product.
- Make sure that there is proper ventilation around the unit in the area where it will operate.
- Make sure all accessories are installed (i.e.. Shelves, shelf clips, casters) before plugging the unit in.
- Please read through the manual in its entirety.

CABINET LOCATION GUIDELINES

- Install the unit on strong and leveled surfaces.
 - Unit may be noisy if surface is uneven.
 - Unit may malfunction if surface is uneven.
- Install the unit in an indoor, well-ventilated area.
 - Unit performs more efficiently in a well-ventilated area.
 - For best performance, please maintain clearance of 4" on the back and side of the unit. Brackets should

Safety and Warranty

be attached on the back of the unit.

- Outdoor use may cause decreased efficiency and damage to the unit.
- Avoid installation in a high humidity and/or dusty area.
 - Humidity could cause unit to rust and decrease efficiency of the unit.
 - Dust collected on condenser coil will cause unit to malfunction.
 - Malfunction due to dirty condenser will void warranty.
- Select a location away from heat and moisture-generating equipment.
 - High ambient temperatures will cause the compressor to overwork, leading to higher energy bills and gradual breakdown of the unit. With the lid open, the unit should not be used in areas over 80 degrees. The unit should not be used in areas over 90 degrees.
 - Malfunction due to high ambient temperature will void warranty.

ELECTRICAL

- Please ensure that the required voltage of the compressor is being supplied at all times. Low or high voltage can detrimentally affect the refrigeration unit.
- All units should be plugged into a grounded and properly-sized electrical outlet with appropriate overcurrent protection. Please refer to the electrical requirements on the nameplate.
- Please make sure that your unit has its own dedicated outlet.
- Do not use an extension cord.

RESIDENTIAL USERS: vendor assumes no liability for parts or labor coverage for component failure or other damages resulting from installation in non-commercial or residential applications. The right is reserved to deny shipment for residential usage; if this occurs, you will be notified as soon as possible.

1 YEAR PART AND LABOUR WARRANTY

Within the warranty period, contact Omcan Inc. at 1-800-465-0234 to schedule an Omcan authorized service technician to repair the equipment locally.

Unauthorized maintenance will void the warranty. Warranty covers electrical and part failures, not improper use.

Please see <https://omcan.com/disclaimer> for complete info.

WARNING:

The packaging components (cardboard, polyethylene, and others) are classified as normal solid urban waste and can therefore be disposed of without difficulty.

In any case, for suitable recycling, we suggest disposing of the products separately (differentiated waste) according to the current norms.

DO NOT DISCARD ANY PACKAGING MATERIALS IN THE ENVIRONMENT!

Technical Specifications

Model	RS-CN-0009-PSS	RS-CN-0006-PSS	RS-CN-0004-PSS
Item Number	46497	46657	46658
Capacity	9 x 1/3 GN Pan	6 x 1/3 GN Pan	4 x 1/3 GN Pan
Refrigerant	R600A		
Electrical	110-120V / 60Hz / 1		
Temperature Range	2 - 8°C / 35.6 - 46.4°F		
Max Ambient Temp Rating	24°C / 75°F		
Net Dimensions	78.7" x 15.6" x 17.1" 2000 x 395 x 435mm	59.1" x 15.6" x 17.1" 1500 x 395 x 435mm	47.2" x 15.6" x 17.1" 1200 x 395 x 435mm
Packaging Dimensions	80.3" x 17.1" x 11" 2040 x 435 x 280mm	60.6" x 17.1" x 11" 1540 x 435 x 280mm	48.8" x 17.1" x 11" 1240 x 435 x 280mm
Net Weight	143.3 lbs. / 65 kgs.	48.5 lbs. / 22 kgs.	26.5 lbs. / 12 kgs.
Packaging Weight	165.3 lbs. / 75 kgs.	70.5 lbs. / 32 kgs.	48.5 lbs. / 22 kgs.

Installation

PACK CONTENTS

The following is included:

- Refrigerator or Freezer.
- Instruction manual.
- Gastranorm adaptor bar.
- Adjustable feet x 4.

We pride itself on quality and service, ensuring that at the time of packaging the contents are supplied fully functional and free of damage. Should you find any damage as a result of transit, please contact Omcan immediately.

Note: if the unit has not been stored or moved In an upright position, let it stand upright for approximately 12 hours before operation.

1. Remove the appliance from the packaging. Make sure that all protective plastic film and coatings are thoroughly removed from all surfaces.
2. Maintain a distance of 20cm (7") between the unit and walls or other objects for ventilation. Increase this distance if the obstacle is a heat source.

Installation

Note: before using the appliance for the first time, clean Interior with soapy water.

3. Level the appliance by adjusting the screw feet.

Operation

TEMPERATURE CONTROLLER



COMMAND LIST



SET To display target set point, in programming mode it selects a parameter or confirm an operation.

 To start a manual defrost.

 In programming mode it browses the parameter codes or increases the displayed value.



 In programming mode it browses the parameter codes or decreases the displayed value.

KEY COMBINATIONS

 +  To lock or unlock the keyboard.

SET +  To enter in programming mode.

SET +  To return to room temperature display.

LED	Mode	Function
	On	Compressor enabled.
	Flashing	Anti short cycle delay enabled (AC parameter).
	On	Defrost in progress.
	Flashing	Dripping in progress.
	On	Measurement unit.
	Flashing	Programming mode.

Operation

°F	On	Measurement unit.
	Flashing	Programming mode.

HOW TO SEE THE SET POINT

1. Push and immediately release the SET key, the set point will be showed.
2. Push and immediately release the SET key or wait about 5s to return to normal visualisation.

HOW TO CHANGE THE SETPOINT

1. Push the SET key for more than 2 seconds to change the Set point value.
2. The value of the set point will be displayed and the “°C” or “°F” LED starts blinking.
3. To change the Set value push the o or n arrows within 10s.
4. To memorise the new set point value push the SET key again or wait 10s.

HOW TO START A MANUAL DEFROST

Push the  key for more than 2 seconds and a manual defrost will start.

HOW TO CHANGE A PARAMETER VALUE

To change the parameter's value operate as follows:

1. Enter the Programming mode by pressing the SET+▼ keys for 3s (“°C” or “°F” LED starts blinking).
2. Select the required parameter. Press the “SET” key to display its value.
3. Use ▲ or ▼ to change its value.
4. Press “SET” to store the new value and move to the following parameter. To exit: Press SET+▲ or wait 15s without pressing a key.

NOTE: the set value is stored even when the procedure is exited by waiting the time-out to expire.

HIDDEN MENU

The hidden menu includes all the parameters of the instrument.

HOW TO ENTER THE HIDDEN MENU

1. Enter the Programming mode by pressing the SET+▼ keys for 3s (“°C” or “°F” LED starts blinking).
2. Released the keys, then push again the SET+▼ keys for more than 7s. The L2 label will be displayed immediately followed from the Hy parameter.
NOW YOU ARE IN THE HIDDEN MENU.
3. Select the required parameter.
4. Press the “SET” key to display its value.
5. Use ▲ or ▼ to change its value.
6. Press “SET” to store the new value and move to the following parameter. To exit: Press SET+▲ or wait 15s without pressing a key.

NOTE: if none parameter is present in L1, after 3s the “nP” message is displayed. Keep the keys pushed till the L2 message is displayed.

NOTE: the set value is stored even when the procedure is exited by waiting the time-out to expire.

HOW TO MOVE A PARAMETER FROM THE HIDDEN MENU TO THE FIRST LEVEL AND VICEVERSA

Each parameter present in the HIDDEN MENU can be removed or put into “THE FIRST LEVEL” (user level) by

pressing **SET+▼**. In HIDDEN MENU when a parameter is present in First Level the decimal point is on.

TO LOCK THE KEYBOARD

1. Keep pressed for more than 3s the ▲ and ▼ keys.
2. The "OF" message will be displayed and the keyboard will be locked. If a key is pressed more than 3s the "OF" message will be displayed.

TO UNLOCK THE KEYBOARD

Keep pressed together for more than 3s the ▲ and ▼ keys till the "on" message will be displayed.

PARAMETERS

REGULATION

Hy - Differential: (0,1°C ÷ 25°C) Intervention differential for set point. Compressor Cut IN is SET POINT + differential (Hy). Compressor Cut OUT is when the temperature reaches the set point.

LS - Minimum SET POINT: (-55°C÷SET/-58°F÷SET): Sets the minimum value for the set point..

US - Maximum SET POINT: (SET÷99°C/ SET÷99°F). Set the maximum value for set point.

ot - First probe calibration: (-9.9÷9.9°C) allows to adjust possible offset of the first probe.

P2 - Evaporator probe presence: n= not present; y= the defrost stops by temperature.

oE - Second probe calibration: (-9.9÷9.9°C) allows to adjust possible offset of the second probe

od - Outputs activation delay at start up: (0÷99min) This function is enabled at the initial start up of the instrument and inhibits any output activation for the period of time set in the parameter.

AC - Anti-short cycle delay: (0÷50 min) minimum interval between the compressor stop and the following restart.

Cy - Compressor ON time with faulty probe: (0÷99 min) time during which the compressor is active in case of faulty thermostat probe. With Cy=0 compressor is always OFF.

Cn - Compressor OFF time with faulty probe: (0÷99 min) time during which the compressor is OFF in case of faulty thermostat probe. With Cn=0 compressor is always active.

DISPLAY

CF - Measurement unit: (°C÷°F) °C =Celsius; °F =Fahrenheit. WARNING: When the measurement unit is changed the SET point and the values of the parameters Hy, LS, US, oE, o1, AU, AL have to be checked and modified if necessary).

rE - Resolution (only for °C): (dE ÷ in) dE= decimal between -9.9 and 9.9°C; in= integer;

Ld - Default display: (P1 ÷ P2) P1= thermostat probe; P2= evaporator probe. SP=Set point

dy - Display delay: (0÷15 min.) when the temperature increases, the display is updated of 1 °C/1°F after this time.

DEFROST

dE - Defrost termination temperature: (-50÷50°C) if ot=Y it sets the temperature measured by the evaporator probe, which causes the end of defrost.

id - Interval between defrost cycles: (0÷99 ore) Determines the time interval between the beginning of two defrost cycles.

Md - Maximum length for defrost: (0÷99 min. with 0 no defrost) when ot=n, (not evaporator probe: timed defrost) it sets the defrost duration, when ot = y (defrost end based on temperature) it sets the maximum

Operation

length for defrost.

dF - Display during defrost: (rt / it / St / dF) rt= real temperature; it= start defrost temperature; St=SET-POINT; dF= label dF.

ALARMS

AU - Maximum temperature alarm: (AL÷99°C) when this temperature is reached the alarm is enabled, after the "Ad" delay time.

AL - Minimum temperature alarm: (-55÷AU°C) when this temperature is reached the alarm is enabled, after the "Ad" delay time.

Ad - Temperature alarm delay: (0÷99 min) time interval between the detection of an alarm condition and alarm signalling.

dA - Exclusion of temperature alarm at startup: (0÷99 min) time interval between the detection of the temperature alarm condition after instrument power on and alarm signalling.

OTHER

d2 - Evaporator probe display (read only).

Pt - Parameter code table.

rL - Software release.

LOADING FOOD PANS

Countertop units are designed to function with all pans in place, even if some pans are to be left empty. For maximum food freshness, fill the pans only with an amount that can be used in a specific usage period. During non-use, please close the insulated lid cover or remove all food.

STORING FOOD

To get the best results from your appliance, follow these instructions:

1. Only store food stuffs in the appliance when it has reached the correct operating temperature.
2. Ensure gastronorm bays are full at all times. Empty bays will greatly reduce efficiency of the appliance.
3. Do not obstruct the fans inside the appliance.

OPERATING

1. Close the door(s) of the appliance.
2. Ensure the power switch is set to (0) and plug into the socket.
3. Switch on the Power (I). The current temperature within the appliance is displayed.

MANUAL DEFROST

The appliance will automatically run a defrost cycle every six hours.

Note: the cycle starts from the time the appliance is initially powered up.

Operation

TO MANUALLY DEFROST THE APPLIANCE:

1. Press and hold the DEFROST button for 5 seconds.
2. The defrost cycle will start immediately and the Defrost LED illuminates. The defrost will last a maximum of 30 minutes.

Note: starting a manual defrost also resets the automatic defrost timer. The next automatic defrost will start six hours after the manual defrost has finished.

3. Waste water is collected in the waste water tray.

Maintenance

WARNING: DISCONNECT POWER CORD BEFORE CLEANING ANY PARTS OF THE UNIT.

CLEANING THE CONDENSER COIL

- For efficient operation, it is important that the condenser surface be kept free of dust, dirt, and lint.
- We recommend cleaning the condenser coil and fins at least once per month.
- Clean with a commercial condenser coil cleaner, available from any kitchen equipment retailer. Brush the condenser fins from top to bottom, not side to side.
- After cleaning, straighten any bent condenser fins with a fin comb.

CLEANING THE FAN BLADES AND MOTOR

If necessary, clean the fan blades and motor with a soft cloth. If it is necessary to wash the fan blades, cover the fan motor to prevent moisture damage.

CLEANING THE INTERIOR OF UNIT

- When cleaning the cabinet interior, use a solvent of warm water and mild soap.
- Do not use steel wool, caustic soap, abrasive cleaners, or bleach that may damage the stainless steel surface.

Troubleshooting

If your appliance develops a fault, please check the following table before call Omcan.

Fault	Probable Cause	Action
Compressor not running.	Fuse blown or circuit breaker tripped.	Replace fuse or reset circuit breaker.
	Power cord unplugged.	Plug in power cord.
	Thermostat set too high.	Set thermostat to lower temperature.
	Cabinet in defrost cycle.	Wait for defrost cycle to finish.
Condensing units run for long periods of time.	Excessive amount of warm product placed in cabinet.	Allow adequate time for product to cool down.
	Dirty condenser coil.	Clean the condenser coil.
	Evaporator coil iced over.	Unplug unit and allow coil to defrost. Make sure thermostat is not set too cold. Ensure that door gasket(s) are sealing properly.
Cabinet temperature is too warm.	Thermostat set too warm.	Set thermostat to lower temperature.
	Excessive amount of warm product placed in cabinet.	Allow adequate time for product to cool down.
	Fuse blown or circuit breaker tripped.	Replace fuse or reset circuit breaker.
	Dirty condenser coil.	Clean the condenser coil.
	Evaporator coil iced over.	Ensure doors are closed when not in use. Avoid opening doors for long periods of time.

CONTROLLER ALARMS

Code	Cause	Additional Notes
P1	Room probe failure.	Compressor output according to "Cy" and "Cn".
P2	Evaporator probe failure.	Defrost end is timed.
HA	Maximum temperature alarm.	Outputs unchanged.
LA	Minimum temperature alarm.	Outputs unchanged.
EA	External alarm.	Outputs unchanged.
CA	Serious external alarm.	All outputs OFF.
dA	Door open.	Compressor and fans restarts.

Parts Breakdown

Model RS-CN-0009-PSS 46497

Model RS-CN-0006-PSS 46657

Model RS-CN-0004-PSS 46658

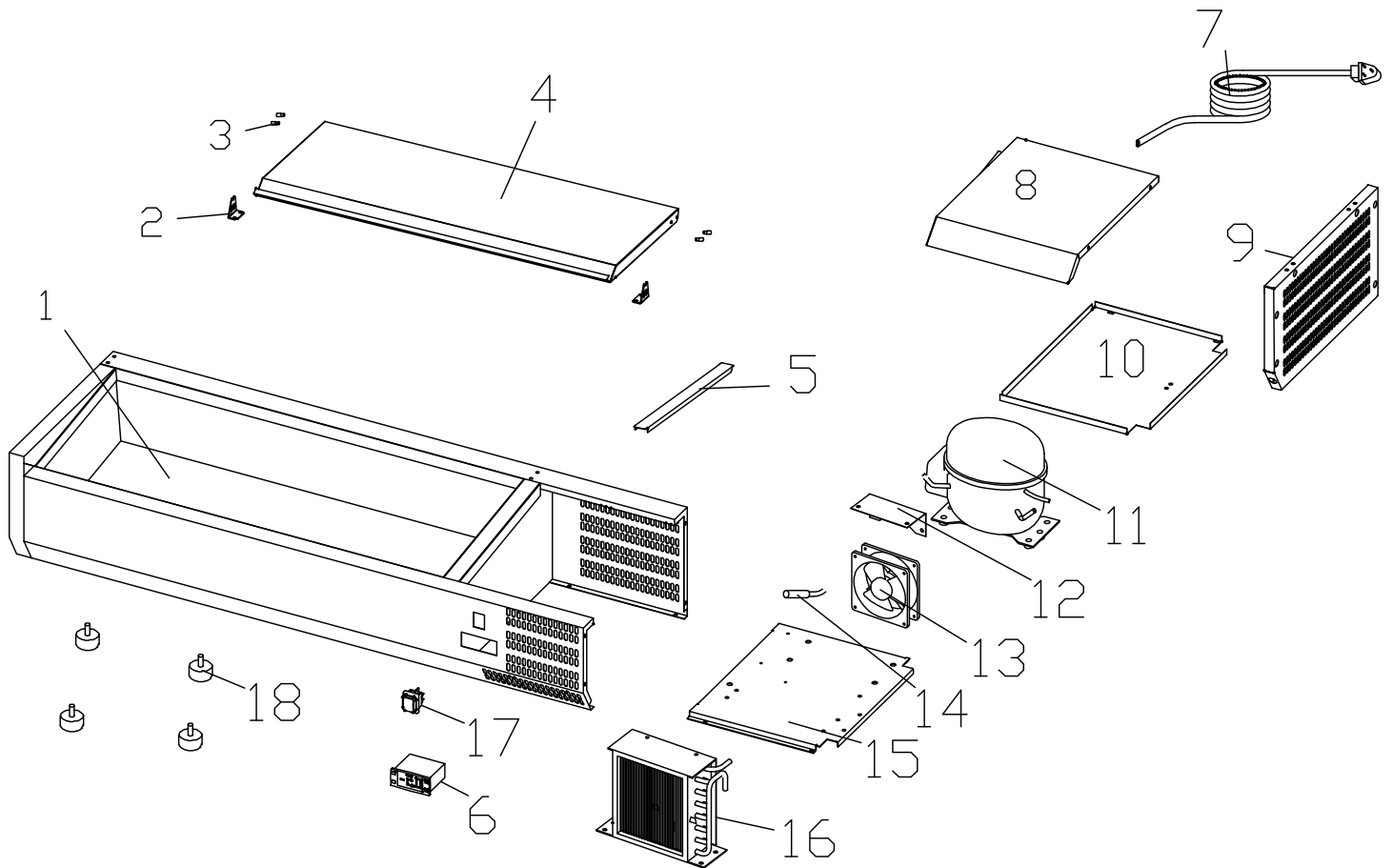

Parts Breakdown

Model RS-CN-0009-PSS 46497

Item No.	Description	Position	Item No.	Description	Position	Item No.	Description	Position
AD812	Body for 46497	1	AD819	Power Cord for 46497	7	AD826	Sensor for 46497	14
AD813	Cover Hinge Left for 46497	2	AD820	Stainless Steel Pan Cover for 46497	8	AD827	Unit Board for 46497	15
AD814	Cover Hinge Right for 46497	2	AD821	Side Cover for 46497	9	AD828	Condenser for 46497	16
AD815	Cover Hinge Axis for 46497	3	AD822	Unit Plate for 46497	10	AD829	Main Switch for 46497	17
AD816	Stainless Steel Lid for 46497	4	AD823	Compressor for 46497	11	AD830	Adjustable Feet for 46497	18
AD817	Pan Support for 46497	5	AD824	Fan Connection Board for 46497	12			
AD818	Thermostat for 46497	6	AD825	Condenser Fan for 46497	13			

Model RS-CN-0006-PSS 46657

Item No.	Description	Position	Item No.	Description	Position	Item No.	Description	Position
AD831	Body for 46657	1	AD819	Power Cord for 46657	7	AD826	Sensor for 46657	14
AD813	Cover Hinge Left for 46657	2	AD820	Stainless Steel Pan Cover for 46657	8	AD827	Unit Board for 46657	15
AD814	Cover Hinge Right for 46657	2	AD821	Side Cover for 46657	9	AD828	Condenser for 46657	16
AD815	Cover Hinge Axis for 46657	3	AD822	Unit Plate for 46657	10	AD829	Main Switch for 46657	17
AD832	Stainless Steel Lid for 46657	4	AD823	Compressor for 46657	11	AD830	Adjustable Feet for 46657	18
AD833	Pan Support for 46657	5	AD824	Fan Connection Board for 46657	12			
AD818	Thermostat for 46657	6	AD825	Condenser Fan for 46657	13			

Model RS-CN-0004-PSS 46658

Item No.	Description	Position	Item No.	Description	Position	Item No.	Description	Position
AD834	Body for 46658	1	AD819	Power Cord for 46658	7	AD826	Sensor for 46658	14
AD813	Cover Hinge Left for 46658	2	AD820	Stainless Steel Pan Cover for 46658	8	AD827	Unit Board for 46658	15
AD814	Cover Hinge Right for 46658	2	AD821	Side Cover for 46658	9	AD828	Condenser for 46658	16
AD815	Cover Hinge Axis for 46658	3	AD822	Unit Plate for 46658	10	AD829	Main Switch for 46658	17
AF203	Stainless Steel Lid for 46658	4	AD823	Compressor for 46658	11	AD830	Adjustable Feet for 46658	18
AD836	Pan Support for 46658	5	AD824	Fan Connection Board for 46658	12			
AD818	Thermostat for 46658	6	AD825	Condenser Fan for 46658	13			

Electrical Schematics

Model RS-CN-0009-PSS 46497

Model RS-CN-0006-PSS 46657

Model RS-CN-0004-PSS 46658

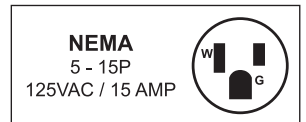
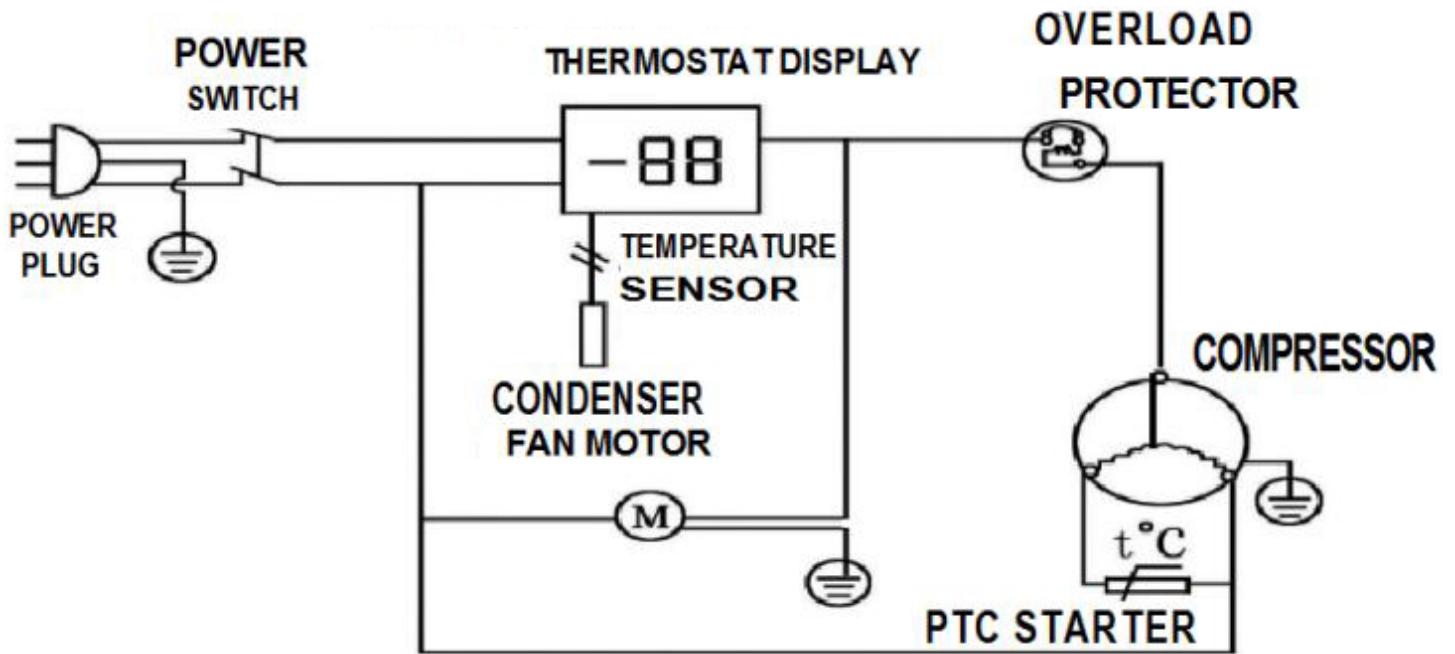



Warranty Registration

Thank you for purchasing an Omcan product. To register your warranty for this product, complete the information below, tear off the card at the perforation and then send to the address specified below. You can also register online by visiting:

Merci d'avoir acheté un produit Omcan. Pour enregistrer votre garantie pour ce produit, complétez les informations ci-dessous, détachez la carte au niveau de la perforation, puis l'envoyer à l'adresse spécifiée ci-dessous. Vous pouvez également vous inscrire en ligne en visitant:

Gracias por comprar un producto Omcan usted. Para registrar su garantía para este producto, complete la información a continuación, cortar la tarjeta en la perforación y luego enviarlo a la dirección indicada a continuación. También puede registrarse en línea en:

<https://omcan.com/warranty-registration/>

For mailing in Canada

Pour postale au Canada

Por correo en Canadá

OMCAN

PRODUCT WARRANTY REGISTRATION

3115 Pepper Mill Court,
Mississauga, Ontario
Canada, L5L 4X5

For mailing in the US

Pour diffusion aux États-Unis

Por correo en los EE.UU.

OMCAN

PRODUCT WARRANTY REGISTRATION

4450 Witmer Industrial Estates, Unit 4,
Niagara Falls, New York
USA, 14305

or email to: service@omcan.com



Purchaser's Information

Name: _____

Address: _____

City: _____ Province or State: _____ Postal or Zip: _____

Country: _____

Dealer from which Purchased: _____

Dealer City: _____ Dealer Province or State: _____

Invoice: _____

Model Name: _____ Model Number: _____

Machine Description: _____

Date of Purchase (MM/DD/YYYY): _____

Would you like to extend the warranty? Yes No

Company Name: _____

Telephone: _____

Email Address: _____

Type of Company:

Restaurant Bakery Deli

Butcher Supermarket Caterer

Institution (specify): _____

Other (specify): _____

Serial Number: _____

Date of Installation (MM/DD/YYYY): _____

Thank you for choosing Omcan | Merci d'avoir choisi Omcan | Gracias por elegir Omcan



Since 1951 Omcan has grown to become a leading distributor of equipment and supplies to the North American food service industry. Our success over these many years can be attributed to our commitment to strengthen and develop new and existing relationships with our valued customers and manufacturers. Today with partners in North America, Europe, Asia and South America, we continually work to improve and grow the company. We strive to offer customers exceptional value through our qualified local sales and service representatives who provide convenient access to over 6,500 globally sourced products.

Depuis 1951 Omcan a grandi pour devenir un des "leaders" de la distribution des équipements et matériel pour l'industrie des services alimentaires en Amérique du Nord. Notre succès au cours de ces nombreuses années peut être attribué à notre engagement à renforcer et à développer de nouvelles et existantes relations avec nos clients et les fabricants de valeur. Aujourd'hui avec des partenaires en Amérique du Nord, Europe, Asie et Amérique du Sud, nous travaillons continuellement à améliorer et développer l'entreprise. Nous nous efforçons d'offrir à nos clients une valeur exceptionnelle grâce à nos ventes locales qualifiées et des représentants de service qui offrent un accès facile à plus de 6500 produits provenant du monde entier.

Desde 1951 Omcan ha crecido hasta convertirse en un líder en la distribución de equipos y suministros de alimentos en América del Norte industria de servicios. Nuestro éxito en estos años se puede atribuir a nuestro compromiso de fortalecer y desarrollar nuevas relaciones existentes con nuestros valiosos clientes y fabricantes. Hoy con socios de América del Norte, Europa, Asia y América del Sur, que trabajan continuamente para mejorar y crecer la empresa. Nos esforzamos por ofrecer a nuestros clientes valor excepcional a través de nuestro local de ventas y representantes de los servicios que proporcionan un fácil acceso a más de 6,500 productos con origen a nivel mundial.

