

INSTRUCTION MANUAL

Mobile Vacuum Packaging

Item	50003	50004	50005
Model	VP-NL-0040-M	VP-NL-0040-MS	VP-NL-0063-M



Warning!

Before you begin using your appliance, **PLEASE READ AND UNDERSTAND THIS DOCUMENT CAREFULLY** before installing, operating, maintaining, or servicing.

There are many important safety messages in this manual and on your appliance. Always read all safety messages.

Failure to do so can result in appliance failure, property damage, serious injury or death. Appliance failure, injury or property damage due to improper installation is not covered by warranty.

Stop!

DO NOT RETURN THIS PRODUCT TO THE STORE!

For questions or assistance with this product, call TRENTO Toll free: **1-833-487-3686** or visit the support section from our website, **www.trentoequipment.com**

Version: Revised - 05/10/2024



TABLE OF CONTENTS

Section	Page
General Information -----	3 - 4
Safety and Warranty -----	4 - 5
Technical Specifications -----	6
Installation -----	6 - 7
Operation -----	7 - 15
Maintenance -----	15 - 19
Troubleshooting -----	20 - 21
Parts Breakdown -----	22 - 30
Electrical Schematics -----	31
Notes -----	32 - 34
Warranty Registration -----	35

GENERAL INFORMATION

Omcan Manufacturing and Distributing Company Inc., Food Machinery of America, Inc. dba Omcan and Omcan Inc. are not responsible for any harm or injury caused due to any person's improper or negligent use of this equipment. The product shall only be operated by someone over the age of 18, of sound mind, and not under the influence of any drugs or alcohol, who has been trained in the correct operation of this machine, and is wearing authorized, proper safety clothing. Any modification to the machine voids any warranty, and may cause harm to individuals using the machine or in the vicinity of the machine while in operation.

CHECK PACKAGE UPON ARRIVAL

Upon receipt of an Omcan shipment please inspect for external damage. If no damage is evident on the external packaging, open carton to ensure all ordered items are within the box, and there is no concealed damage to the machine. If the package has suffered rough handling, bumps or damage (visible or concealed), please note it on the bill of lading before accepting the delivery and contact Omcan within 24 hours, so we may initiate a claim with the carrier. A detailed report on the extent of the damage caused to the machine must be filled out within three days, from the delivery date shown in the shipping documents. Omcan has no recourse for damaged products that were shipped collect or third party.

Before operating any equipment, always read and familiarize yourself with all operation and safety instructions.

Omcan would like to thank you for purchasing this machine. It's of the utmost importance to save these instructions for future reference. Also save the original box and packaging for shipping the equipment if servicing or returning of the machine is required.

Omcan Fabrication et distribution Compañie Limité et Food Machinery d'Amérique, dba Omcan et Omcan Inc. ne sont pas responsables de tout dommage ou blessure causé du fait que toute personne ait utilisé cet équipement de façon irrégulière. Le produit ne doit être exploité que par quelqu'un de plus de 18 ans, saine d'esprit, et pas sous l'influence d'une drogue ou d'alcool, qui a été formé pour utiliser cette machine correctement, et est vêtu de vêtements de sécurité approprié. Toute modification de la machine annule toute garantie, et peut causer un préjudice à des personnes utilisant la machine ou des personnes à proximité de la machine pendant son fonctionnement.

VÉRIFIEZ LE COLIS DÈS RÉCEPTION

Dès réception d'une expédition d'Omcan veuillez inspecter pour dommages externes. Si aucun dommage n'est visible sur l'emballage externe, ouvrez le carton afin de s'assurer que tous les éléments commandés sont dans la boîte, et il n'y a aucun dommage dissimulé à la machine. Si le colis n'a subi aucune mauvaises manipulations, de bosses ou de dommages (visible ou cachée), notez-le sur le bond de livraison avant d'accepter la livraison et contactez Omcan dans les 24 heures qui suivent, pour que nous puissions engager une réclamation auprès du transporteur. Un rapport détaillé sur l'étendue des dommages causés à la machine doit être rempli dans un délai de trois jours, à compter de la date de livraison indiquée dans les documents d'expédition. Omcan n'a aucun droit de recours pour les produits endommagés qui ont été expédiées ou cueilli par un tiers transporteur.

Avant d'utiliser n'importe quel équipement, toujours lire et vous familiariser avec toutes les opérations et les

GENERAL INFORMATION

consignes de sécurité.

Omcan voudrais vous remercier d'avoir choisi cette machine. Il est primordial de conserver ces instructions pour une référence ultérieure. Également conservez la boîte originale et l'emballage pour l'expédition de l'équipement si l'entretien ou le retour de la machine est nécessaire.

Omcan Empresa De Fabricacion Y Distribucion Inc. Y Maquinaria De Alimentos De America, Inc. dba Omcan y Omcan Inc. no son responsables de ningun daño o perjuicio causado por cualquier persona inadecuada o el uso descuidado de este equipo. El producto solo podra ser operado por una persona mayor de 18 años, en su sano juicio y no bajo alguna influencia de droga o alcohol, y que este ha sido entrenado en el correcto funcionamiento de esta máquina, y ésta usando ropa apropiada y autorizada. Cualquier modificación a la máquina anula la garantía y puede causar daños a las personas usando la máquina mientras esta en el funcionamiento.

REVISE EL PAQUETE A SU LLEGADA

Tras la recepcion de un envio Omcan favor inspeccionar daños externos. Si no hay daños evidentes en el empaque exterior, Habra el carton para asegurarse que todos los articulos solicitados estén dentro de la caja y no encuentre daños ocultos en la máquina. Si el paquete ha sufrido un manejo de poco cuidado, golpes o daños (visible o oculto) por favor anote en la factura antes de aceptar la entrega y contacte Omcan dentro de las 24 horas, de modo que podamos iniciar una reclamación con la compañía. Un informe detallado sobre los daños causados a la máquina debe ser llenado en el plazo de tres días, desde la fecha de entrega que se muestra en los documentos de envío. Omcan no tiene ningun recurso por productos dañados que se enviaron a recoger por terceros.

Antes de utilizar cualquier equipo, siempre lea y familiarizarse con todas las instrucciones de funcionamiento y seguridad.

Omcan le gustaría darle las gracias por la compra de esta máquina. Es de la mayor importancia para salvar estas instrucciones para futuras consultas. Además, guarda la caja original y el embalaje para el envío del equipo si servicio técnico o devolución de la máquina que se requiere.

SAFETY AND WARRANTY

The manufacturer of this equipment accepts no liability whatsoever for damage or injury caused by failing to adhere to the directions and instructions in this manual, or through carelessness during the installation, use, maintenance and repair of the machine identified on the front of this document, or any of its accompanying options or components.

The owner of the machine is fully responsible at all times for the adherence to the locally applicable safety regulations and guidelines. Obey all safety instructions and guidelines as provided in this manual.

SAFETY AND WARRANTY

INTENDED USE OF THE MACHINE

The machine is designed for vacuum packaging of food or other products for 8 hours a day, 5 days a week. Any other or extended use is not in accordance with this purpose and the manufacturer accepts no liability for any resulting damage or injury. Only use this machine while in perfect technical condition in accordance with the above mentioned purpose.

SAFETY MEASURES

The machine is equipped with the following standard safety devices:

- Short-circuit and overload safety.
- Pump fan guards.

All safety devices must be correctly installed and may only be removed to accommodate maintenance and repair activities by trained and authorized service personnel. The machine may never be operated while safety measures are incomplete, deactivated or absent. The safety devices may never be by-passed.

RESIDENTIAL USERS: vendor assumes no liability for parts or labor coverage for component failure or other damages resulting from installation in non-commercial or residential applications. The right is reserved to deny shipment for residential usage; if this occurs, you will be notified as soon as possible.

1 YEAR PARTS AND LABOR WARRANTY

Within the warranty period, contact Trento Inc. at 1-800-465-0234 to schedule a Trento authorized service technician to repair the equipment locally.

Unauthorized maintenance will void the warranty. Warranty covers electrical and part failures, not improper use.

Please see <https://omcan.com/disclaimer> for complete info.

WARNING:

The packaging components are classified as normal solid urban waste and can therefore be disposed of without difficulty.

In any case, for suitable recycling, we suggest disposing of the products separately (differentiated waste) according to the current norms.

DO NOT DISCARD ANY PACKAGING MATERIALS IN THE ENVIRONMENT!

TECHNICAL SPECIFICATIONS

Model	VP-NL-0040-M	VP-NL-0040-MS	VP-NL-0063-M
Item Number	50003	50004	50005
Seal Length	19.7" / 500mm		31.5" 19.7" 800 500mm
Vacuum Pump	40 m ³		63 m ³
10 Programmable Control	Yes		
Maximum Product Height	6.9" / 175mm		8.5" / 215mm
Useful Chamber Size	19.7" x 19.7" 500 x 500mm		19.68" x 31.5" 500 x 800mm
Power Consumption	3.3 kW		3.5 kW
Electrical	220V / 60Hz / 3	220V / 60Hz / 1	220V / 60Hz / 3
Weight	330 lbs. / 150 kgs.		440 lbs. / 200 kgs.
Dimensions	26.8" x 27.4" x 40.7" 680 x 695 x 1035mm		29.7" x 35.6" x 41.7" 755 x 905 x 1060mm

INSTALLATION

GENERAL

- Level the machine on a flat firm surface.
- Position the machine in such a manner that the pump is unobstructed and properly ventilated.
- Engage the locks on the wheels, if so equipped.
- Check the oil level in the pump; add oil if necessary.

Never operate the machine when the oil level is low. It is recommended to change the oil at least every 2 months.

TURNING ON MACHINE

- If so equipped, like some mobile and double-chamber models, turn on the main power switch on the back of the machine.
- Push the on/off button on the control panel of the machine.

GAS CONNECTION FOR MAP APPLICATIONS (MODIFIED ATMOSPHERIC PACKAGING)

- Connect the gas supply line to the inlet on the back of the machine.
- Maximum pressure: 1 bar.
- Anchor the gas cylinders securely to prevent them from falling over.
- Make sure that the work area is well-ventilated.
- To assure that you use the appropriate gas for your application, consult your dealer or gas supplier.

INSTALLATION

- Assure a good connection and use high-quality materials.

COMPRESSED AIR CONNECTION FOR ADDITIONAL SEALING PRESSURE

- Additional sealing pressure is usually recommended for MAP applications only.
- The M40-M80 and the L10-L60 models with the option gas/MAP are standard equipped with a compressed air inlet.
- Extra sealing pressure is not necessary and not available for the table-top, M10, M20, M30.
- Consult your dealer for installation details.
- Maximum pressure: 1 bar.
- Assure a good connection and use high-quality connector.

OPERATION

DIGITAL CONTROL WITH LCD DISPLAY

Some Henkovac vacuum machines have a control system with just one program (P1). Other machines have an optional expanded control system, which can accommodate up to 9 custom programs (P1-9).

ONE-PROGRAM CONTROL SYSTEM

Henkovac machines with the one-program control system can be programmed for the following 2 functions:



















1. Vacuum time (seconds).
 2. Sealing time (seconds).
- The values for vacuum and sealing times are selected by the user and saved in program P1.
 - During operation, the LCD display will show symbols to indicate the active function and the progress of the packing cycle.
 - The actual vacuum pressure is indicated by the analog vacuum gauge.

PLUG AND PLAY







- When turning on the machine for the first time:
 - Running time of the vacuum pump is pre-set at 30-40 seconds and the sealing time at 2 seconds. Vacuum is indicated on the analog vacuum gauge.
- When turning on the machine after that, program P1 will contain the most-recently used settings.
- The vacuum and sealing times are easily adjusted to match the needs for the application.

OPERATION

OPERATING THE MACHINE WITH ONE-PROGRAM CONTROL SYSTEM

	<p>On: turns the machine on:</p> <ul style="list-style-type: none"> The machine will start up in the most-recently used program. The pump of a machine with a transparent cover will start when the cover is closed. <p>Off: turns the machine off:</p> <ul style="list-style-type: none"> When pressing the  button once, the  symbol will start blinking and the pump will stop after about 4 seconds. When pressing the  button a second time, the pump will stop immediately. Closing the cover will initiate the cool-down phase; the machine will complete a number of vacuum cycles before turning off automatically.
	<p>Stop-function:</p> <ul style="list-style-type: none"> Stops the machine at any point in the packing cycle and aerates the chamber. <p>Reset-function:</p> <ul style="list-style-type: none"> While programming, resets the program value to its original setting. Press the menu button  to return to the home menu.
	<p>Stops the current function and initiates the next step in the cycle:</p> <ul style="list-style-type: none"> By pressing the  of the sealing button , the vacuum function stops and the program jumps to the sealing function. While packing sauce or soup, the package may be sealed as soon as product boiling is detected.
	<p>Entering the desired vacuum time :</p> <p>By pressing the + or – of the vacuum button, the vacuum time can be increased or decreased.</p> <p>The selected value is confirmed and saved by pressing the menu button :</p> <ul style="list-style-type: none"> Press the  button to reset the original value.
	<p>Entering the desired sealing time :</p> <ul style="list-style-type: none"> By pressing the + or – of the sealing button, the sealing time can be increased or decreased. <p>The selected value is confirmed and saved by pushing the menu button :</p> <ul style="list-style-type: none"> Press the  button to reset the original value.
	<p>Menu button:</p> <ul style="list-style-type: none"> Confirms and saves the entered values for vacuum and sealing times. Returns to the home menu.

OPERATION

	<p>When turning off the machine with the  button, the  symbol will start blinking:</p> <ul style="list-style-type: none"> • The pump will stop after about 4 seconds. • Press the  button a second time and the pump will stop immediately. • Close the lid; the machine initiates the cool-down phase and perform a number of vacuum cycles before turning off automatically. • These additional cycles allow any moisture in the oil of the pump to evaporate. This increases the longevity of the machine and minimizes the need for oil changes and pump maintenance.
	<p>Service symbol:</p> <ul style="list-style-type: none"> • After a number of operating hours or packing cycles, the service symbol will briefly appear on the display when the machine is turned on. In addition, the display indicates how many hours or cycles remain before an oil change is required. • Except for regularly changing the oil in the pump (important!), the machine requires little other routine maintenance. • To reset the service interval counters after the oil change: start machine  and while the display shows the hours or cycles, press and hold the  button.

TEN-PROGRAM CONTROL SYSTEM

In addition to vacuum and sealing times, Henkovac machines with a ten-program control system may be programmed for several additional functions. Each of the 9 customizable programs is either:

1. Time controlled.
2. Sensor controlled.

TIME-BASED OPERATION (VACUUM GAUGE: MBAR)

- The values for vacuum and sealing time, as well as the values for several optional functions, are selected by the customer and saved in any of 9 customizable programs P1-9.
- When operating a packaging machine with a time-based program, the actual vacuum pressure is indicated by the analog vacuum gauge. The number of seconds of vacuum time remaining is shown on the LCD display.

PLUG AND PLAY

- When turning on a time-based machine for the first time, it will start up in the PA program AUTOMATIC. This is a pre-set factory program with 30-40 seconds vacuum time and 2 seconds of sealing time.
- When turning on the machine after that, it will start up in the most-recently used program.

OPTIONAL INSTALLATION OF A SENSOR OR SOFT-AIR

- A machine with a time-based control program can be upgraded to sensor-based operation at a later date by installing the optional sensor kit.
- The soft-air feature can also be installed at a later date by ordering the optional soft-air kit.

SENSOR-BASED OPERATION (DIGITAL DISPLAY: MBAR)

- When operating a packaging machine with a sensor-based program, the actual vacuum pressure is digitally

OPERATION

shown on the LCD display in mbar (standard setting) or in % vacuum.











PLUG AND PLAY

- When turning on a sensor-based machine for the first time, it will start up in the PA program AUTOMATIC. This is a pre-set factory program with 5 mbar of vacuum and 2 seconds of sealing time.
- When turning on the machine after that, it will start up in the most-recently used program.



OPTIONAL INSTALLATION OF SOFT-AIR

- The soft-air feature can also be installed at a later date by ordering the optional soft-air kit.

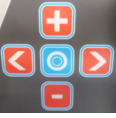

OPERATING THE MACHINE WITH TEN-PROGRAM CONTROL SYSTEM

	<p>On: turns the machine on:</p> <ul style="list-style-type: none"> • The machine will start up in the most-recently used program. • The pump of a machine with a transparent cover will start when the cover is closed. <p>Off: turns the machine off:</p> <ul style="list-style-type: none"> • When pressing the  button once, the  symbol will start blinking and the pump will stop after about 4 seconds. • When pressing the  button a second time, the pump will stop immediately. • Closing the cover will initiate the cool-down phase. • The machine will complete a number of vacuum cycles before turning off automatically.
	<p>Stop-function:</p> <ul style="list-style-type: none"> • Stops the machine at any point in the cycle and aerates the chamber. <p>Reset-function:</p> <ul style="list-style-type: none"> • While programming, resets the program value to its original setting. • Press the menu button  to return to the home menu. <p>Back function:</p> <ul style="list-style-type: none"> • While reviewing programmed values, returns to the previous selection.
	<p>Stops the active function and initiates the next step in the cycle:</p> <ul style="list-style-type: none"> • While the machine is running, exits the active function and jumps to the next step in the cycle. • While packing sauce or soup, the package may be sealed as soon as product boiling is detected.
	<p>Menu button:</p> <ul style="list-style-type: none"> • Toggles between home menu  and settings menu . • Save function: during programming, confirms and saves the entered program values and returns to the home menu. • Return function: returns to the home menu.

OPERATION

	<p>Review program values:</p> <ul style="list-style-type: none"> • Cycles through programs P1 to P9, as well as PA and P H2O. • Displays the programmed value for each function; the function being reviewed will be blinking. • Displays the value for the next function. • Returns to the home menu.
	<p>Adjust program values and turn functions ON/OFF:</p> <ul style="list-style-type: none"> • Forward or back; adjusted values are saved right away. • Increases or decreases function values. • Turns functions ON/OFF; specific functions, like soft-air, clean cut seal, etc., are turned either on or off. • If the function is turned on, the value may be adjusted by pressing the and buttons. • Resets the original value. • Saves changes and returns to the home menu.
	<p>Multi-functional button: performs various functions, depending on the active menu:</p> <p>Home menu :</p> <ul style="list-style-type: none"> • No effect while in the PA program. • For programs P1-9, displays the entered values. <p>Settings menu :</p> <ul style="list-style-type: none"> • For specific functions, like soft-air, clean cut seal etc., the button is used to turn the function ON/OFF.
<p>P1 – P9</p>	<p>Programs 1 through 9:</p> <ul style="list-style-type: none"> • Each program may be customized by turning certain functions on or off and by adjusting the function values.
<p>PA AUTOMATIC</p>	<p>PA - Automatic:</p> <ul style="list-style-type: none"> • Program with factory settings for vacuum and sealing functions, which is activated when turning on the machine for the first time.
<p>P H₂O</p>	<p>P H₂O – Program:</p> <ul style="list-style-type: none"> • To be used when packing liquids or semi-liquids, like sauces and soups. • Program jumps to the sealing function as soon as product boiling is detected; this prevents product loss through spillage and evaporation.
	<p>When turning off the machine with the button, the symbol will start blinking on the LCD display:</p> <ul style="list-style-type: none"> • The pump will stop after about 4 seconds. • Press the button for a second time and the pump will stop immediately. • Close the lid; the machine will initiate the cool-down phase and perform a number of vacuum cycles before turning off automatically. • These additional cycles allow any moisture in the oil of the pump to evaporate. This increases the longevity of the machine and minimizes the need for oil changes and pump maintenance.

OPERATION

	<p>Service symbol:</p> <ul style="list-style-type: none"> • After reaching a certain number of operating hours or packing cycles, the service symbol will briefly appear on the display when turning on the machine. In addition, the display indicates how many hours or cycles remain before an oil change is required. • Except for regularly changing the oil in the pump, the machine requires little other routine maintenance. • After reaching the service limit, the display will indicate the negative number of exceeded operating hours or cycles. • To reset the service interval counters after the oil change: start machine  and while the display shows the hours or cycles, press and hold the  button to reset.
---	---

PROGRAMMING THE MACHINE

ONE-PROGRAM CONTROL SYSTEM



- The one-program control system is standard on the S20, S30, S40, S50, M10, M30 (with 21m³ pump).
- The one-program control system is time-based.
- The ten-program control system (time or sensor) is optional for these models, except for S20.

THE ONE-PROGRAM CONTROL SYSTEM PROVIDES ONLY ONE PROGRAM (P1)

- There is no memory to store additional values.
- The machine starts with the values that were most-recently used.
- The pump starts upon closing of the cover and stops when it is reopened.

PROGRAMMABLE FUNCTIONS



The following function values may be customized for P1:

-  Vacuum time: in seconds.
-  Sealing time: in seconds.



PROGRAMMING

1. Turn the machine on by pressing the on/off button.
 - a. The factory setting for the vacuum time is 30-40 seconds.
 - b. The factory settings for the seal time is 2 seconds.



REVIEWING VACUUM TIME AND SEALING TIME

1. Press the  button to display the programmed vacuum time the vacuum time is pre-set at the factory.
2. Press the  button to display the programmed sealing time the sealing time is pre-set at the factory at 2 seconds. 





ADJUSTING VACUUM TIME FOR P1

1. Press twice on the  or  button.
 - After pressing once, the programmed value is displayed.



OPERATION

- After pressing twice, the  symbol will start blinking and the value may be adjusted.
- 2. Save the new value by pressing the menu button.
- 3. To retain the original value, press the  button.
- 4. Exit the program by pressing the menu button.

ADJUSTING SEALING TIME FOR P1

1. Press twice on the  or  button.
 - After pressing once, the programmed value is displayed.
 - After pressing twice, the  symbol will start blinking and the value may be adjusted.
2. Save the new value by pressing the menu button.
3. To retain the original value, press the  button.
4. Exit the program by pressing the menu button.

TURNING OFF MACHINE

1. Turn the machine off by pressing the  button.
2. The  symbol on the display will start blinking.
3. Push the  button a second time and the pump will stop immediately.
4. If no action is taken the pump turns off after 4 seconds.
5. Close the cover and the machine will initiate the cool-down phase and perform a number of vacuum cycles while the cover stays closed and the machine will turn off automatically after about 15 minutes.
 - These cycles are necessary to cool down the machine and to allow any moisture in the oil of the pump to evaporate.







TEN-PROGRAM CONTROL SYSTEM

- The ten-program control system is standard time-based on the M20, M40-M80, L01-L60.
 - Sensor-based operation is an option, which can be installed at a later date.
- The ten-program control system provides:
 - 9 customizable programs (P1-P9).
 - Program PA; this is an - automatic program – pre-set at the factory at a vacuum time of 30-40 seconds (or 5 mbar for a sensor-based program) and a sealing time of 2 seconds.
- Program P H2O for liquid products.
 - When turning on the machine, the pump will start. After about 15 minutes of inactivity, the pump will stop automatically.







OPERATION

PROGRAMMABLE FUNCTIONS









The following functions may be customized for each program P1-P9:

-  **Vacuum time:** in seconds or mbar (only with sensor).
-  **Sealing time:** in seconds.
-  **Vacuum plus:** on/off, in seconds.
-  **Gassing:** on/off, in seconds or mbar (only with sensor).
-  **Clean cut controlled (CCC) seal:** on/off, in seconds.
-  **Soft-air:** on/off, in seconds or mbar (only with sensor).
-  **Multi-cycle:** on/off, in number of cycles.

REVIEWING FUNCTION VALUES FOR P1-P9





1. Turn the machine on by pushing the  button.
2. The most-recently used program will be indicated.
3. All selected functions for this program are indicated at the bottom of the display.
4. To review the values for these functions, push the  button; use the    button to display each function value.
5. The values cannot be changed; this can only be done in the settings menu.
6. Push the  button to return to the home menu.

PROGRAMMING AND ADJUSTING VALUES FOR P1-P9



1. Select the program to be set up or adjusted.
2. Push the menu button to access the settings menu.
3. All functions for the selected program are indicated at the bottom of the display.
4. Push the    button to select the blinking function to be adjusted.
5. Adjust the value of the selected function with the  button.
6. Press the  button to reset all functions to their original values.
7. Select the next function with the    button.
8. Press the menu button to save the entered values and to return to the home menu.

TURNING PROGRAM FUNCTIONS ON/OFF



The following functions can be turned ON/OFF for each program P1-P9:

-  **Vacuum plus:** on/off, in seconds.
-  **Gassing:** on/off, in seconds or in mbar (only with sensor).
-  **Clean cut controlled (CCC) seal:** on/off, in seconds.
-  **Soft-air:** on/off, in seconds or in mbar (only with sensor).
-  **Multi-cycle:** on/off, in number of cycles.

ADJUSTING ON/OFF FUNCTION VALUES

1. Press the menu button to select the settings menu.
2. Use the    button to select the blinking function to be adjusted.

OPERATION

3. Press the  button to select the desired value.
4. Press the  button to reset all functions to their original values.
5. Select the next function with the  button.
6. Push the menu button to store all selected values and to return to the home menu.

TURNING OFF MACHINE

- Follow the same procedure as for the one-program control system.

MAINTENANCE

GENERAL

Regular maintenance prevents equipment malfunctions and prolongs the life of the machine. In addition, it optimizes sanitary conditions.

- Always have a certified Henkovac dealer carry out repair and maintenance activities.

WARNING

- During maintenance activities, always turn the machine off at the main switch and/or unplug it from the electrical outlet.



ATTENTION

Observe the recommended service intervals. Overdue maintenance may lead to costly repairs and overhauls, and may void the equipment warranty.

- After reaching a programmed number of operating hours or packing cycles, the service symbol  will briefly appear on the display when the machine is started up. In addition, the display will indicate how many hours or cycles remain before an oil change is required.
- After passing the service limit, the display will indicate the negative number of excess operating hours or cycles.



VACUUM PUMP

To protect the vacuum pump, proper maintenance is important. Carry out the following tasks carefully:

- Check the vents and clean as necessary before turning on the machine to assure proper cooling of the pump.
- When the air filter is saturated with oil, an oil mist may be expelled; replacement of the filter is required.
- Use the cool-down/dehumidification feature. When turning off the machine  and closing the cover , the pump continues to run for some time. Any moisture in the oil of the pump will evaporate during this phase. This increases the longevity of the machine and minimizes the need for oil changes and pump maintenance.
- Check the oil level regularly and add as needed.
- Change the oil when the service symbol  appears on the display.

MAINTENANCE

NOTE

To reset the service interval counters after the oil change: start machine  and while the display shows the hours or cycles, press and hold the  button.

ADDING AND CHANGING THE PUMP OIL

WARNING

The operating temperature of the pump is 70°C / 158°F or higher. Wear gloves when servicing the pump or let it cool off sufficiently to prevent injuries.

ADDING OIL

1. Remove the oil filler cap
2. Add oil up to the maximum-level mark; use oil according to DIN 51506, lubrication oil group VC. When in doubt, consult your dealer.
3. Replace the oil filler cap.
4. After several packing cycles, check the oil level and add as needed.

CHANGING OIL

1. Remove the oil drain plug and drain the oil.
2. Replace the drain plug.
3. Remove the oil filler cap.
4. Add the correct oil up to the maximum-level mark.
5. Replace the oil filler cap.
6. To reset the service interval counters after the oil change: start machine and while the display shows the hours or cycles, press and hold the  button.

NOTE

Collect the oil to have it processed and recycled according to the locally applicable regulations.

Note: hydraulic oil to be used is Trento item 15713.

SEAL BEAMS AND COUNTER BEAMS

To achieve a quality seal, it is necessary that the seal beam and counter beam are in good condition.

1. Clean the seal and counter beams daily with a dry cloth.
2. Replace the Teflon tape on the seal beam if damaged and replace the sealing wire if kinked.
3. Replace the silicone rubber seal if it is burned in.

Depending on the type of machine, there are three seal beam versions:

1. Single-seal beam (T2).
2. Stainless steel seal beam.
3. Aluminum seal beam.

MAINTENANCE

SINGLE-SEAL BEAM

REMOVE THE SEALING WIRE AND TEFLON TAPE AS FOLLOWS:

1. Grab the seal beam in the middle and pull it straight up and out of the machine.
2. The beam is held in place by 2 pins; some force may be necessary to loosen the beam.
3. Remove the brown Teflon tape that is applied to the seal beam.
4. Remove the two screws on the underside of the seal beam; this releases the sealing wire.
5. Clean the seal beam thoroughly and remove any glue residue off the Teflon tape.

NOTES

- Check the condition of the tensioning springs at both ends of the seal beam; replace if necessary.
- These springs maintain tension on the sealing wire.
- Using the seal beam without the springs may cause sealing wires to break.

INSTALL THE SEALING WIRE AND TEFLON TAPE AS FOLLOWS:

1. Position the sealing wire across the beam and fasten it on one side with a small bolt.
2. Apply tension on the wire by pulling it with a pair of pliers.
3. Fasten the wire on the opposite end of the beam with the second bolt and cut the wire to length; the ends of the sealing wire must be long enough to make electrical contact with the pins in the vacuum chamber.
4. Apply the Teflon tape smooth and tight over the seal beam; make sure that the beam is clean and free of grease.
5. Re-install the beam in the vacuum chamber; check to make sure that the ends of the sealing wire make contact with the steel pins.

ALUMINUM/STAINLESS STEEL SEAL BEAM

REMOVE THE SEALING AND CUTTING WIRES AS FOLLOWS:

1. Remove the old wires by pulling them loose from the seal beam contacts.
2. Loosen the clamp screws and remove the seal beam from the U-profile.
3. Remove the Teflon tape from the seal beam.
4. Remove the mounting plates on both ends of the seal beam by loosening the screws; this releases the sealing wires and/or sealing and cutting wires.
5. Clean the seal beam thoroughly.

NOTES

- After removal of the wires, check the strips of fiber glass for damage; replace if necessary.
- Check the condition of the tensioning springs at both ends of the seal beam; replace if necessary.
- Using the seal beam without the springs may cause the sealing wires to break.
- Check contact plate for damage; replace if necessary.

INSTALL THE SEALING AND CUTTING WIRES AS FOLLOWS:

1. If necessary, install new strips of fiber glass on the seal beam.
2. Insert the new wires behind one of the mounting plates and tighten the screws; make sure that the end of the wires line up with the bottom edge of the mounting plate.
3. Position the wires across the seal beam and loosely install the second mounting plate.

MAINTENANCE

4. Carefully clamp the seal beam upside down in a bench vice.
5. Pull the wires as tightly as possible with a pair of pliers and secure the second mounting plate by tightening the screws.

NOTE

1. The wires can be further tightened by slightly loosening the screws of one of the mounting plates.
2. Pull the wires one-by-one tighter with a pair of pliers.
3. Re-tighten the screws after the correct tension has been achieved.
4. Cut the end of the wires flush with the bottom edge of the mounting plate.
5. Apply the Teflon tape smooth and tight over the seal beam without creases. Make sure that the beam is clean and free of grease.
6. Re-install the seal beam in the vacuum chamber and re-connect the wires.

ALUMINUM T-SHAPED SEAL BEAM

REMOVE THE SEALING WIRES AS FOLLOWS:

1. Remove the seal beam from the machine.
2. Remove the Teflon tape.
3. Loosen the screws on both sides of the beam; this will release the sealing wires.
4. Clean the seal beam thoroughly.

INSTALL THE SEALING WIRES AS FOLLOWS:

1. Apply new fiber glass to the beam if necessary.
2. Place new wires on the beam and fasten them on one side with mounting plates; tighten the screws.
3. Position the wires across the beam.
4. Fasten mounting plates; tighten screws.
5. Carefully clamp the beam in a bench vice.
6. Pull the wires as tightly as possible with a pair of pliers.
7. Secure the mounting plates with the screws.

NOTES

- Check the strip of fiber glass for damage and replace if necessary.
- Check the springs and replace if necessary.
- Using the seal beam without the springs may cause the sealing wires to break.

APPLYING TEFLON TAPE TO SEAL BEAM

1. Position the new Teflon tape on the seal beam and cut out the corners.
2. Remove the protective backing from the Teflon tape.
3. Apply the new tape to the seal beam; the tape has an adhesive strip on both sides.
4. Slide the seal beam onto the pins in the vacuum chamber (machines with transparent cover).
5. Slide the seal beam in the holder of the cover, tighten the mounting screws, and re-connect the wires (machines with metal cover).

MAINTENANCE

NOTE

- The Teflon tape must not adhere to the tension blocks.

REPLACING SILICONE RUBBER SEAL OF COUNTER BEAM

The rubber seal is clamped in the counter beam. Replace the counter beam seal as follows:

1. Pull the old rubber seal from the groove in the counter beam.
2. Clean the groove.
3. Evenly press the new rubber seal into the groove and make sure that it does not stick out at either end of the counter beam.

RUBBER SEAL OF VACUUM CHAMBER COVER

To assure that the vacuum chamber is properly sealed, it is important that the rubber seal is in good condition and is not damaged. Replace the cover seal as follows:

1. Copy the length of the original rubber seal.
2. Pull the original rubber seal from the groove.
3. Clean the groove.
4. Evenly press the rubber seal into the groove; position the ends of the seal tightly against each other to prevent leakage.

STRUTS, DAMPERS AND SPRINGS

- Machines with transparent covers are equipped with gas struts to open the cover.
- Machines with metal covers are equipped with oil dampers and springs to open the cover.
- Have the struts, dampers and springs checked by your dealer once every 5 years and have them replaced as necessary.
- Have the gas struts replaced if the lid no longer opens properly.

VACUUM HOSES AND TUBES

- Check the vacuum hoses and tubes for kinks, tears and porosity; replace if necessary.

TROUBLESHOOTING

Fault/Symptom	Possible Cause	Remedy
Machine does not work.	The machine is not plugged in.	Plug the machine into the electrical outlet.
	The ground fault safety in the electrical panel has tripped.	Check the electrical panel.
	A fuse in the electrical panel is faulty.	Check the electrical panel.
	A fuse in the machine is faulty.	Consult your dealer.
	The motor protection of the machine is switched off.	Consult your dealer.
The vacuum pump does not run at full speed.	The oil is too thick or contaminated.	Change the oil.
	The pump motor runs on two phases.	Check the voltage; if correct, consult your dealer.
The vacuum in the package is insufficient.	The programmed vacuum value is too high.	Lower the vacuum value in the program.
	The packaging material is of poor quality.	Select a better-quality packaging material.
	The product damages the bag.	Program a higher value for soft-air.
	The machine gases the package.	Turn off the gassing function.
The seal is leaking.	The package seam is poorly formed.	Increase the sealing time and/or reduce the MAP gas pressure.
	The package seam is burnt.	Decrease the sealing time.
	The opening of the vacuum bag is contaminated.	Try again and make sure that the opening of the bag stays clean.
	The sealing beam is dirty.	Clean the sealing beam.
	The Teflon lining of the sealing beam is damaged.	Replace the Teflon lining.
	The silicon rubber seal in the counter beam is damaged.	Replace the silicon rubber seal.

TROUBLESHOOTING

There is not enough gas in the bag.	The bag is too small.	Select a bigger bag.
	The programmed gas level is too low.	Increase the gas level value.
	The bag is not correctly positioned over the gas outlets.	Adjust the bag position.
The machine does not seal.	The bag is not correctly positioned over the sealing beam.	Adjust the bag position.
	The sealing wire is broken.	Replace the sealing wire.
	The thermal safety of the power supply was tripped.	Wait until the safety resets, which can take half an hour. Decrease the sealing time.
	The electrical contacts of the seal beam have fouled.	Remove the seal beam and clean the pins and contacts with sand paper.
The service symbol appears when turning on the machine, indicating the remaining production hours or cycles.	The service interval counters have reached their maximum programmed values.	To reset the service interval counters after the oil change: start the machine and while the display shows the hours or cycles, press and hold the "X" button.

PARTS BREAKDOWN

ITEM	MODEL
50003	VP-NL-0040-M
50004	VP-NL-0040-MS

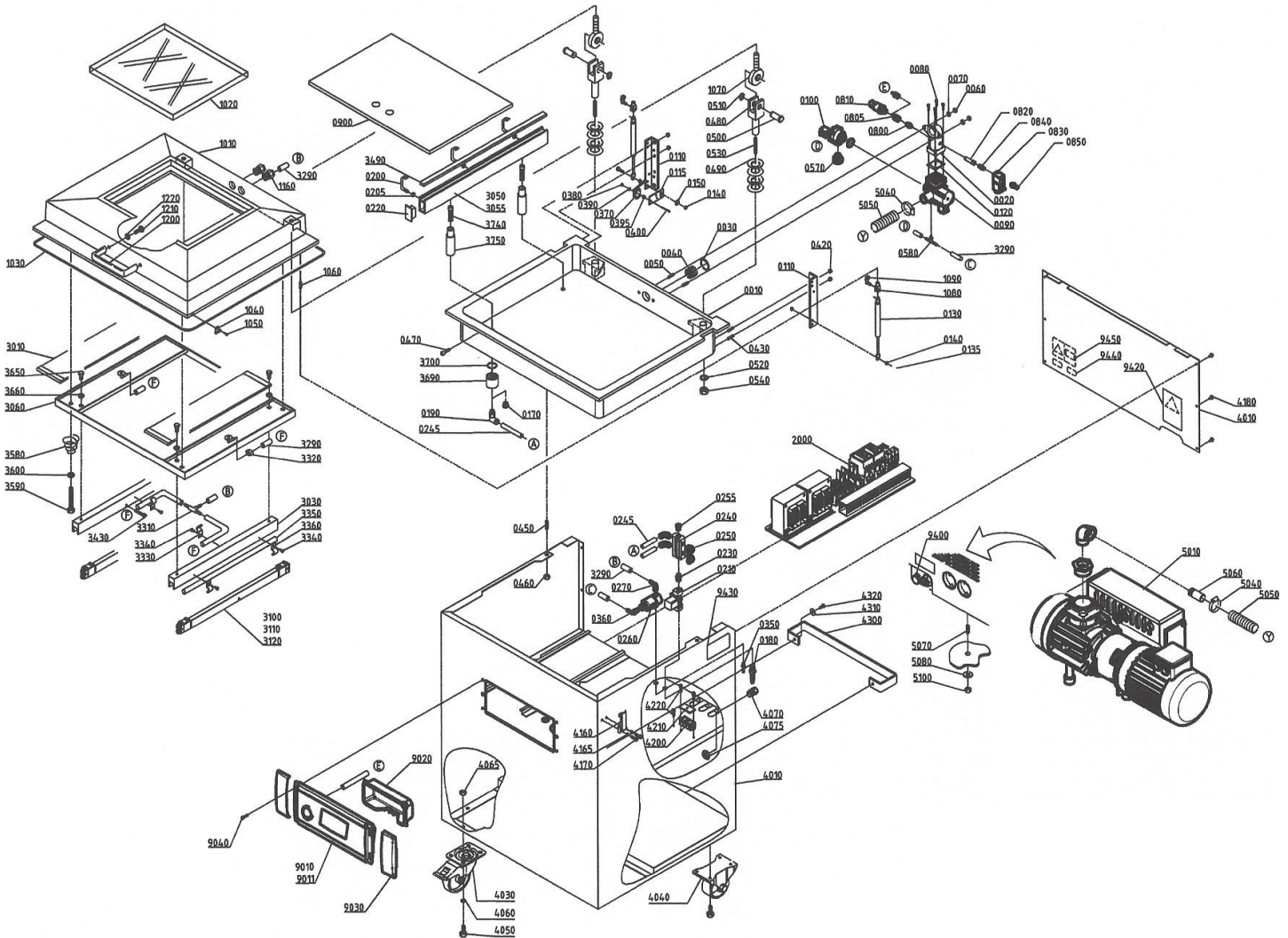

PARTS BREAKDOWN

ITEM	MODEL
50003	VP-NL-0040-M
50004	VP-NL-0040-MS

Item No.	Description	Position	Item No.	Description	Position	Item No.	Description	Position
35230	Vacuum Chamber Complete for 50003, 50004	0010	35250	Gas Nozzle Universal for 50003, 50004	0200	35270	Adj.Screw/Soc.Head M6x20 DIN916 A2 for 50003, 50004	0450
35231	Branch Pipe HFE-1 Ready for 50003, 50004	0020	35251	Hexagon Nut M8x1 Low DIN439B for 50003, 50004	0205	27781	Hexagon Flangenut M6 DIN6923 A2 for 50003, 50004	0460
35232	O-Ring 32x3 for 50003, 50004	0030	35252	Gas Valve for Gas Distribution for 50003, 50004	0210	35272	Hex.Socket Head Cap Screw M5x8 DIN912 A2 for 50003, 50004	0470
35233	Filter for 50003, 50004	0040	35253	Closing Plug Silicon Holder for 50003, 50004	0220	35273	Hinge Pin for 50003, 50004	0480
35234	Adj.Screw/Soc.Head M8x30 DIN916 A2 for 50003, 50004	0050	35254	Reducing Nipple 1/2x3/8 for 50003, 50004	0230	35274	Spring Collar for 50003, 50004	0490
27814	Hexagon Nut M8 DIN934 A2 for 50003, 50004	0060	35255	Distribution Block 4DVB/VP 3/8-1/4-4 for 50003, 50004	0240	35275	Safety Pin Hinge for 50003, 50004	0500
35236	Spring Ring M8 DIN127 A2 for 50003, 50004	0070	35256	Air Pressure Hose Blue 10x8 for 50003, 50004	0245	35276	Spring Ring 12mm DIN471 for 50003, 50004	0510
35237	Hex.Socket Head Cap Screw M5x30 DIN912 A2 for 50003, 50004	0080	35257	Insert Coupling Straight 1/4x10 for 50003, 50004	0250	27827	Flat Washer M10 D9021 A2 for 50003, 50004	0520
15722	Vacuum Valve without Decomp. Head 32mm for 50003, 50004	0090	35258	Blind Plug 3/8 MS/VN for 50003, 50004	0255	27826	Adj.Screw/Soc.Head M10x50 D916 A2 for 50003, 50004	0530
15723	Decompress Head Vacuumvalve 32mm for 50003, 50004	0100	15716	3-Way Valve for 50003, 50004	0260	35279	Self Locking Hexagon Nut M10 DIN985 VZ for 50003, 50004	0540
35240	Support Gas Cylinder for 50003, 50004	0110	30015	Square Hose Coupling 1/4x6 Ext. for 50003, 50004	0270	27819	Square Hose Coupling 1/8"x6 Ext. for 50003, 50004	0550
35241	Support Microswitch MV3000 for 50003, 50004	0115	35261	Brass Hose Coupling 1/4x8 Ext. for 50003, 50004	0350	15751	Decompress Filter 1/2" for 50003, 50004	0570
35242	Packing Branch Pipe Mobiles for 50003, 50004	0120	30015	Square Hose Coupling 1/4x6 Ext. for 50003, 50004	0360	35282	T-Screw-In Hose Coupling 1/8x6 Ext. for 50003, 50004	0580
15756	Gas Cylinder 1000320 (1X) for 50003, 50004	0130	15775	Micro Switch MV3003L for 50003, 50004	0370	35203	Plug Plastic 1/8 for 50003, 50004	0810
35244	Hexagon Screw M6x25 DIN933 A2 for 50003, 50004	0135	27823	Hexagon Nut M3 DIN934 A2 for 50003, 50004	0380	35284	Extension Piece Oil Drain for 50003, 50004	0820
35245	Hexagon Nut M6 DIN934 A2 for 50003, 50004	0140	27822	Castle Washer M3 for 50003, 50004	0390	35285	Valve 2/2 MA-222-003-P27-SAH 24 for 50003, 50004	0830
27786	Flat Washer M6 D9021 A2 for 50003, 50004	0150	35266	Distance Bush PCB Main for 50003, 50004	0395	35205	Brass Double Nipple 1/8 for 50003, 50004	0840
35247	Blind Stopper + O-Ring 1/4 MS/VN for 50003, 50004	0170	30011	Slotted Cheese Head Screw M3x20 A2 DIN84 for 50003, 50004	0400	35225	Silencer ID-CL 1/8 for 50003, 50004	0850
35248	Hose Coupling 1/2x10 Ext. for 50003, 50004	0180	27781	Hexagon Flangenut M6 DIN6923 A2 for 50003, 50004	0420	65830	Insert Plate 200-Basic for 50003, 50004	0900
35249	Elbow Coupling 10x1/4 for 50003, 50004	0190	27788	Adj.Screw/Soc.Head M6x25 DIN916 A2 for 50003, 50004	0430	35289	Vacuum Cover SB-520 Complete for 50003, 50004	1010

PARTS BREAKDOWN

ITEM	MODEL
50003	VP-NL-0040-M
50004	VP-NL-0040-MS

Item No.	Description	Position	Item No.	Description	Position	Item No.	Description	Position
35290	Sight Glass 200 (380x280x20) for 50003, 50004	1020	15784	TMBR AB193-TAB40 2 4-4 0A for 50003, 50004	2080	35330	Valve Cord CC2-02 for 50003, 50004	2260
35105	Sil.Profile Lidgasket 8mm 60 SH/25MTR for 50003, 50004	1030	15785	TMBR AB193-TAB60 4 0-6 0A for 50003, 50004	2081	35331	Cable Channel 40x40 for 50003, 50004	2280
35292	Lid Locker Hook V951L7-1BP for 50003, 50004	1040	15786	TMBR AB193-TAC10 6 0-10 0A for 50003, 50004	2082	35332	Cable Microswitch for 50003, 50004	2290
35293	Slotted Cheese Head Screw M3x5 A2 DIN84 for 50003, 50004	1050	15787	TMBR AB193-TAC16 10 0-16 0A for 50003, 50004	2083	35333	WM01 Feed Transformer Primary for 50003, 50004	2300
27788	Adj.Screw/Soc.Head M6x25 DIN916 A2 for 50003, 50004	1060	15781	TMBR AB193-TAPM Montage Sokkel for 50003, 50004	2085	35334	WM05 Looping Transformer Primary for 50003, 50004	2330
35295	Rod End Hinge Cover for 50003, 50004	1070	35315	Double Clamp 2.5-2 for 50003, 50004	2090	35335	WM06 Mas Pump-Threading Clamp for 50003, 50004	2340
27808	Adjusting Fork for 50003, 50004	1080	15771	Closed Contactor AB100-C09KJ400 24VAC for 50003, 50004	2110	35336	WM11 Pump Cable MAS-MBS 2.5 for 50003, 50004	2350
27809	Adjusting Fork Closing Pin for 50003, 50004	1090	35317	Earth Terminal PE 6-10 for 50003, 50004	2130	35337	WC04 Control Transformer Fuse-Clip for 50003, 50004	2360
35298	Cable Gland M20x1.5 Brass for 50003, 50004	1160	35318	Wire Clamp 6-2/2 AN for 50003, 50004	2140	35338	WE02 Ground Cord Machine-PE 2.5 for 50003, 50004	2370
35299	Handle GN-565-26-192-SW 800 for 50003, 50004	1200	35319	Rail JMV35SL 9-Hole 220mm for 50003, 50004	2150	35714	Interconnection Double MAS100C09 for 50003, 50004	2380
35300	Hexagon Screw M8x20 DIN933 A2 for 50003, 50004	1210	35320	Hex.Socket Head Cap Screw M4x8 DIN912 A2 for 50003, 50004	2170	15936	Sealbag 3000800-K(KL)L=340mm for 50003, 50004	3010
35301	Castle Washer Red Copper M8 for 50003, 50004	1220	34998	Flat Washer M4 D9021 A2 for 120/140 P32/Carriage Ring M4 for 50003, 50004	2175	31553	Pressure Beam H-2000 for 50003, 50004	3030
35302	Mounting Plate 160x455x5 for 50003, 50004	2000	35322	Earth Terminal M4 1x45-GR for 50003, 50004	2180	35342	Silicon Holder for 50003, 50004	3050
15792	Combi-Trafo P200/460V-S24/32V for 50003, 50004	2020	35323	End Plate Wire Connector for 50003, 50004	2190	35343	Silicon Holder for 50003, 50004	3055
35304	Earth Terminal PE 4-2/3 for 50003, 50004	2030	35324	Seal Cord C1-07 for 50003, 50004	2200	35344	Sealing Mechanism for 50003, 50004	3060
35305	End Fent for 50003, 50004	2050	35325	Seal Cord KK C1-22 for 50003, 50004	2205	15889	Seal Beam Single Seal L=500mm Complete for 50003, 50004	3100
35306	Fuse Clamp 2.5-2/ZSI for 50003, 50004	2060	35326	Control Cable CC1-01 for 50003, 50004	2210	35346	Seal Beam DS/1/495 for 50003, 50004	3110
35307	Fuse Keram.5x20 2.5A Delay for 50003, 50004	2070	35327	Network-Cord CM 1-11 for 50003, 50004	2220	35347	Seal Beam TS/4/495 for 50003, 50004	3120
15818	Fuse 5x20 4A Slow for 50003, 50004	2075	35328	Feed Main Switch CM2-04 for 50003, 50004	2230	35348	Seal Beam 8mm/4/495 for 50003, 50004	3130
15817	Fuse 5x20 8A Slow for 50003, 50004	2076	35329	Pump Cord CM4-09 for 50003, 50004	2250	27837	Hose (O2) Drago 6x13 for 50003, 50004	3290

PARTS BREAKDOWN

ITEM	MODEL
50003	VP-NL-0040-M
50004	VP-NL-0040-MS

Item No.	Description	Position	Item No.	Description	Position	Item No.	Description	Position
27836	Connecting Piece T-Piece 6mm for 50003, 50004	3310	35367	Bottom Section for 50003, 50004	4010	35384	Safety Clamp Vacuum Pump for 50003, 50004	4300
30019	Hose Clip Klemfa 12.8x14.8mm for 50003, 50004	3320	35368	Spring Control Box for 50003, 50004	4020	27786	Flat Washer M6 D9021 A2 for 50003, 50004	4310
35352	Cable Clamp 1x12mm DIN7257 for 50003, 50004	3330	35369	Swivel Castor Black ST.ST. 100mm for 50003, 50004	4030	27787	Hexagon Screw M6x16 DIN933 A2 for 50003, 50004	4320
35353	Self Tapping Screw PIAS 3.5x9.5 for 50003, 50004	3340	35370	Fixed Castor STST. for 50003, 50004	4040	35387	Vac Pump 040-132 230/400-3-50 E for 50003, 50004	5010
35354	Tube Alu 10x1mm L=400mm for 50003, 50004	3350	35211	Hexagon Screw M8x16 DIN933 A2 for 50003, 50004	4050	35388	Hose Clip ABA 32-44mm for 50003, 50004	5040
35355	Cable Clip 1x10mm DIN72571 for 50003, 50004	3360	35372	Castle Washer M8 for 50003, 50004	4060	15833	PVC Suction Hose HNA-32x42mm for 50003, 50004	5050
31554	Adj.Screw/Soc.Head M6x6 DIN916 A2 for 50003, 50004	3430	27814	Hexagon Nut M8 DIN934 A2 for 50003, 50004	4065	35390	Pipe Nipple Half 1/2 1 for 50003, 50004	5060
15842	Silicone T Profile 40 Shore One Meter for 50003, 50004	3490	35298	Cable Gland M20x1.5 Brass for 50003, 50004	4070	35391	Adj.Screw/Soc.Head M8x25 DIN916 A2 for 50003, 50004	5070
35358	Conical Compression Spring for 50003, 50004	3580	35375	Nut M20x1.5 MS for 50003, 50004	4075	35219	Flat Washer M8 D9021 A2 for 50003, 50004	5080
35359	Hexagon Bolt M6x40 DIN931 A2 for 50003, 50004	3590	35376	Cable Gland M20x1.5 Plastic for 50003, 50004	4080	27814	Hexagon Nut M8 DIN934 A2 for 50003, 50004	5100
27824	Castle Washer M6 for 50003, 50004	3600	35377	Lid Locker for 50003, 50004	4160	65754	Cover Protection 04-Control for 50003, 50004	9020
27787	Hexagon Screw M6x16 DIN933 A2 for 50003, 50004	3650	27822	Castle Washer M3 for 50003, 50004	4165	65753	Cap Wide Holder 04-Control for 50003, 50004	9030
27824	Castle Washer M6 for 50003, 50004	3660	35293	Slotted Cheese Head Screw M3x5 A2 DIN84 for 50003, 50004	4170	27789	Slott.Rais.Counter.Head Screw M4x10 DIN7985 A2 for 50003, 50004	9040
35507	Holing Block Silicon Holder HD-03 for 50003, 50004	3690	35380	Slotted Cheese Head Screw M4x12 A2 DIN84 for 50003, 50004	4180	35419	Sticker Tension + Warning for 50003, 50004	9420
35364	O-Ring 27x2.5 for 50003, 50004	3700	35381	Terminal Block 4-Pole for 50003, 50004	4200	27794	Sticker Machine Type for 50003, 50004	9430
35365	Mounting Screw Holing Block HD-03 for 50003, 50004	3740	35382	Cover Connection Block 4-Pole for 50003, 50004	4210	35223	Sticker 19x38 Yellow for 50003, 50004	9440
35366	Spacer Sil.Holder Gas 42mm for 50003, 50004	3750	35383	Slotted Cheese Head Screw M4x16 A2 DIN84 for 50003, 50004	4220	35224	Sticker 98x65 Yellow for 50003, 50004	9450

PARTS BREAKDOWN

ITEM	MODEL
50005	VP-NL-0063-M

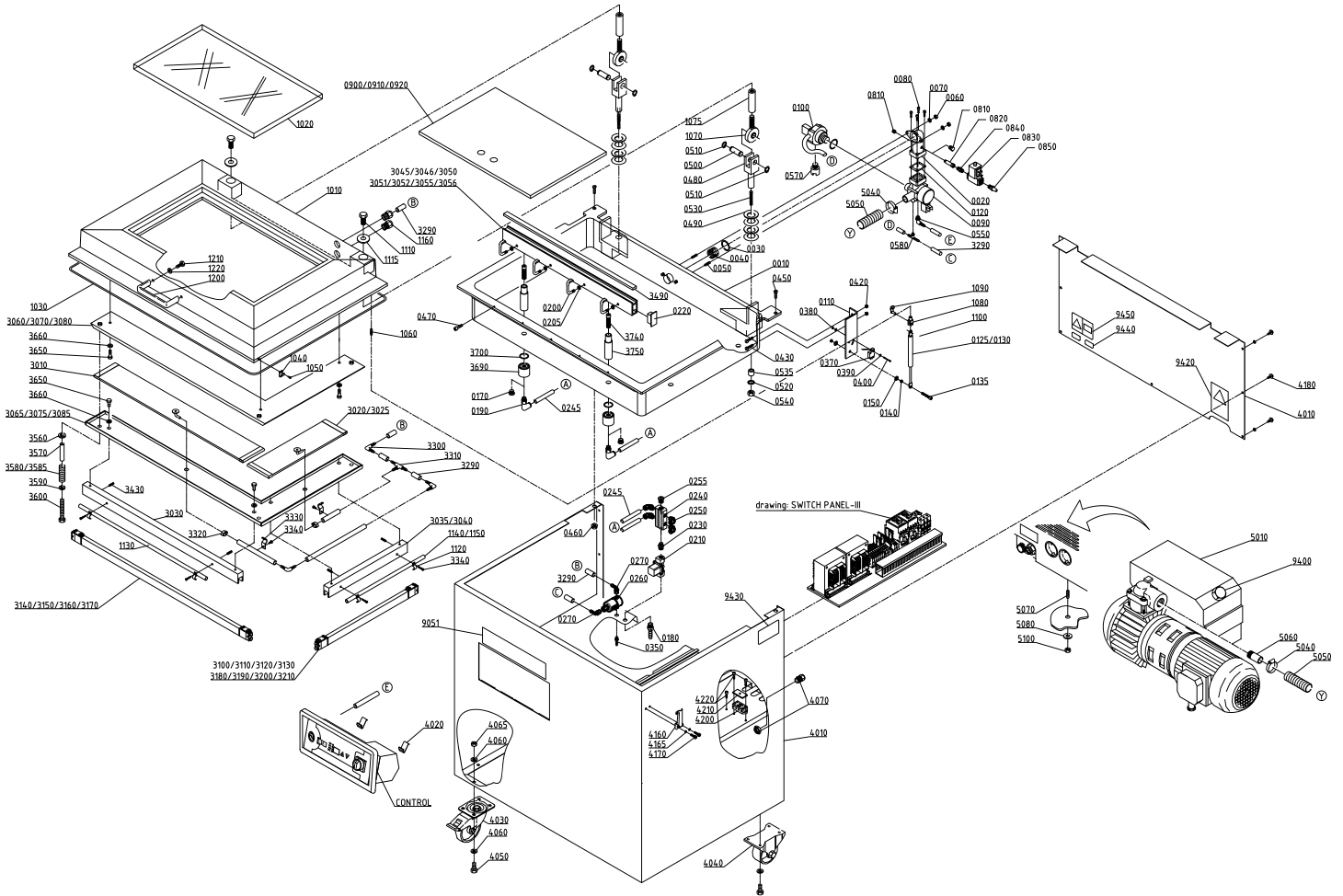

PARTS BREAKDOWN

ITEM	MODEL
50005	VP-NL-0063-M

Item No.	Description	Position	Item No.	Description	Position	Item No.	Description	Position
35590	Vacuum Chamber Complete for 50005	10	35252	Gas Valve for Gas Distribute Pot for 50005	210	35276	Spring Ring 12mm Din471 for 50005	510
35231	Branch Pipe HFE-1 Ready for 50005	20	35253	Closing Plug Silicone Holder for 50005	220	27827	Flat Washer M10 D9021 A2 for 50005	520
35232	O-Ring 32x3 for 50005	30	35254	Reducing Nipple 1/2"x3/8" for 50005	230	35636	Adj.Screw/Soc.Head M10x60 Din913 A2 for 50005	530
35233	Filter for 50005	40	35255	Distribution Block 4DVB/VP 3/8"-1/4"-4 for 50005	240	35637	Bush Hinge Pin SB-820 for 50005	535
35234	Adj.Screw/Soc.Head M8x30 Din916 A2 for 50005	50	35256	Air Pressure Hose Blue 10x8 for 50005	245	35279	Self Locking Hexagon Nut M10 Din985 VZ for 50005	540
27814	Hexagon Nut M8 Din934 A2 for 50005	60	35257	Insert Coupling Straight 1/4"x10 for 50005	250	27819	Square Hose Coupling 1/8"x6 Ext. for 50005	550
35236	Spring Ring M8 Din127 A2 for 50005	70	35258	Blind Plug 3/8" MS/VN for 50005	255	15751	Decompress Filter 1/2 for 50005	570
35597	Hex.Socket Head Cap Screw M5x35 Din912 A2 for 50005	80	15716	3-Way Valve for 50005	260	35282	T-Screw-in Hose Coupling 1/8"x6 Ext. for 50005	580
15722	Vacuum Valve without Decomp. Head 32mm for 50005	90	30015	Square Hose Coupling 1/4"x6 Ext. for 50005	270	35203	Plug Plastic 1/8" for 50005	810
15723	Decompress Head Vacuum Valve 32mm for 50005	100	35261	Brass Hose Coupling 1/4"x8 Ext. for 50005	350	35284	Extension Piece Oil Drain for 50005	820
35600	Support Gas Cylinder SB-820 for 50005	110	15775	Micro Switch MV3003L for 50005	370	35285	Valve 2/2 MA-222-003-P27-SAH 24 for 50005	830
35242	Packing Branch Pipe Mobiles for 50005	120	27823	Hexagon Nut M3 Din934 A2 for 50005	380	35205	Brass Double Nipple 1/8" for 50005	840
15754	Gas Cylinder (H-3000) for 50005	125	27822	Castle Washer M3 for 50005	390	35225	Silencer ID-CL 1/8 for 50005	850
35603	Gas Cylinder 084174 / 500N for 50005	130	30011	Slotted Cheese Head Screw M3x20 A2 Din84 for 50005	400	35647	Protection Suction Hole SB-820-LL for 50005	860
35604	Hexagon Screw M8x30 Din933 A2 for 50005	135	27781	Hexagon Flangenut M6 Din6923 A2 for 50005	420	35648	Insert Plate SB-820 KL for 50005	900
27814	Hexagon Nut M8 Din934 A2 for 50005	140	35627	Hex.Sock.Counter Head Screw M6x20 D7991 A2 for 50005	430	35649	Insert Plate SB-820 LL for 50005	910
35219	Flat Washer M8 D9021 A2 for 50005	150	35628	Hex.Sock.Counter Head Screw M6x16 D7991 A2 for 50005	450	35650	Insert Plate SB-820 KK for 50005	920
35247	Blind Stopper + O-Ring 1/4 MS/VN for 50005	170	27781	Hexagon Flangenut M6 Din6923 A2 for 50005	460	35651	Vacuum Cover SB-820 Complete for 50005	1010
35248	Hose Coupling 1/2"x10 Ext. for 50005	180	35272	Hex.Socket Head Cap Screw M5x8 Din912 A2 for 50005	470	35652	Sight Glass SB-820 (560x315x20) for 50005	1020
35249	Elbow Coupling 10x1/4" for 50005	190	35273	Hinge Pin for 50005	480	35105	Sil.Profile Lid Gasket 8mm 60°SH/25MTR for 50005	1030
35250	Gas Nozzle Universal for 50005	200	35274	Spring Collar for 50005	490	35292	Lid Locker Hook V951L7-1BP for 50005	1040
35251	Hexagon Nut M8x1 Low Din439B for 50005	205	35275	Safety Pin Hinge for 50005	500	35293	Slotted Cheese Head Screw M3x5 A2 Din84 for 50005	1050

PARTS BREAKDOWN

ITEM	MODEL
50005	VP-NL-0063-M

Item No.	Description	Position	Item No.	Description	Position	Item No.	Description	Position
27788	Adj.Screw/Soc.Head M6x25 Din916 A2 for 50005	1060	15818	Fuse 5x20 4A Slow for 50005	2075	35700	Pump Cord CM4-13 for 50005	2251
35295	Rod End Hinge Cover for 50005	1070	15817	Fuse 5x20 8A Slow for 50005	2076	35330	Valve Cord CC2-02 for 50005	2260
35658	Wire Bush M12 (Cover SB-820) for 50005	1075	15784	TMBR AB193-TAB40 2 4-4 0A for 50005	2080	35702	Cable Looping Seal Beam for 50005	2270
27808	Adjusting Fork for 50005	1080	15781	TMBR AB193-TAPM Mounting Base for 50005	2085	35331	Cable Channel 40x40 for 50005	2280
27809	Adjusting Fork Closing Pin for 50005	1090	35315	Double Clamp 2,5-2 for 50005	2090	35332	Cable Microswitch for 50005	2290
35661	Bearing Bush PAP-0606-P10 for 50005	1100	15771	Closed Contactor 24VAC for 50005	2110	35333	WM01 Feed Transformer Primary for 50005	2300
35662	Hexagon Screw M12x25 Din933 A2 for 50005	1110	35317	Earth Terminal PE 6-10 for 50005	2130	35706	WM02 Looping Mas Seal 1 2.5 for 50005	2310
35663	Flat Washer M12 Din9021 A2 for 50005	1115	35318	Wire Clamp 6-2/2 AN for 50005	2140	35334	WM05 Looping Transformer Primary for 50005	2330
35355	Cable Clip 1x10mm Din72571 for 50005	1120	35319	Rail JMV35SL 9-Hole 220mm for 50005	2150	35335	WM06 Mas Pump-Threading Clamp for 50005	2340
35665	Tube Alu 10x1mm L=680mm SB-820 for 50005	1130	35687	Wire Clamp 2.5-2/2 AN for 50005	2160	35336	WM11 Pump Cable Mas-Mbs 2.5 for 50005	2350
35666	Tube Alu 10x1mm L=370mm SB-820 for 50005	1140	35688	Clamp Connector 2.5/2 for 50005	2165	35710	WC01 Control-Cable Mas Seal 1,0 for 50005	2360
35667	Tube Alu 10x1mm L=420mm for 50005	1150	35320	Hex.Socket Head Cap Screw M4x8 Din912 A2 for 50005	2170	35711	WC03 Looping Clixon for 50005	2370
35298	Cable Gland M20x1,5 Brass for 50005	1160	34998	Flat Washer M4 D9021 A2 Carriage Ring M4 for 50005	2175	35337	WC04 Control Transformer Fuse-Clip for 50005	2380
35299	Handle GN-565-26-192-SW 800 for 50005	1200	35322	Earth Terminal M4 1x45-GR for 50005	2180	35338	WE02 Ground Cord Machine-PE 2,5 for 50005	2390
35300	Hexagon Screw M8x20 Din933 A2 for 50005	1210	35323	End Plate Wire Connector for 50005	2190	35714	Interconnection Double MAS100C09 for 50005	2400
35301	Castle Washer Red Copper M8 for 50005	1220	35324	Seal Cord C1-07 for 50005	2200	15935	Seal Bag 3000800-L L=620mm for 50005	3010
35672	Plate 495x230x5 for 50005	2000	35326	Control Cable CC1-01 for 50005	2210	15936	Seal Bag 3000800-K(KL) L=340mm for 50005	3020
15792	Combi-Trafo P200/460V-S24/32V for 50005	2020	35327	Network-Cord CM 1-11 for 50005	2220	15937	Seal Bag 3000800-K(KK) L=375mm for 50005	3025
35304	Earth Terminal PE 4-2/3 for 50005	2030	35696	Network-Cord CM1-03 for 50005	2221	35718	Pressure Beam SB-820-L for 50005	3030
35305	End Fent for 50005	2050	35328	Feed Main Switch CM2-04 for 50005	2230	35719	Pressure Beam SB-820-K(KL) for 50005	3035
35306	Fuse Clamp 2,5-2/ZSI for 50005	2060	35698	Feed Main Switch CM2-02 for 50005	2231	35720	Pressure Beam SB-820-K for 50005	3040
35307	Fuse Keram.5x20 2.5A Delay for 50005	2070	35329	Pump Cord CM4-09 for 50005	2250	35721	Silicon Holder SB-820-K for 50005	3045

PARTS BREAKDOWN

ITEM	MODEL
50005	VP-NL-0063-M

Item No.	Description	Position	Item No.	Description	Position	Item No.	Description	Position
35722	Silicon Holder SB-820-K-G for 50005	3046	62579	Sealbeam 8mm/1/540 for 50005	3200	35368	Spring Control Box for 50005	4020
35723	Silicon Holder SB-820-K (KL) for 50005	3050	15891	Seal Beam Single Seal L=550mm Complete for 50005	3210	35369	Swivel Castor Black ST.ST. 100mm for 50005	4030
35724	Silicon Holder SB-820-K(KL)-G Right for 50005	3051	27837	Hose (O2) Drago 6x13 for 50005	3290	35370	Fixed Castor STST. for 50005	4040
35725	Silicon Holder SB-820-K(KL)-G Left for 50005	3052	30016	Square Connect Piece 6mm for 50005	3300	35211	Hexagon Screw M8x16 Din933 A2 for 50005	4050
35726	Silicon Holder SB-820-L for 50005	3055	27836	Connecting Piece T-Piece 6mm for 50005	3310	35372	Castle Washer M8 for 50005	4060
35727	Silicon Holder SB-820-L-G for 50005	3056	30019	Hose Clip Klemfa 12.8x14.8mm for 50005	3320	27814	Hexagon Nut M8 Din934 A2 for 50005	4065
35728	Sealing Mechanism SB-820-L Top for 50005	3060	35352	Cable Clamp 1x12mm Din7257 for 50005	3330	35298	Cable Gland M20x1,5 Brass for 50005	4070
35729	Sealing Mechanism SB-820-LL Bottom for 50005	3065	35353	Self Tapping Screw Pias 3.5x9.5 for 50005	3340	35375	Nut M20x1.5 MS for 50005	4075
35730	Seal Mechanism SB-820-KL Top for 50005	3070	31554	Adj.Screw/Soc.Head M6x6 Din916 A2 for 50005	3430	35376	Cable Gland M20x1,5 Plastic for 50005	4080
35731	Seal Mechanism SB-820-KL Bottom for 50005	3075	15842	Silicone T-Profil 40 Shore One Meter for 50005	3490	35377	Lid Locker for 50005	4160
35732	Seal Mechanism SB-820-K Upper for 50005	3080	35447	Castle Washer M10 for 50005	3560	27822	Castle Washer M3 for 50005	4165
35733	AI Mechanism Under for 50005	3085	35755	Protect.Case Bolt Seal.Mechanism 10x1x50mm for 50005	3570	35293	Slotted Cheese Head Screw M3x5 A2 Din84 for 50005	4170
15889	Seal Beam Single Seal L=500mm Complete for 50005	3100	35756	Spring Cutting System TPS/Seal M. SB-820 for 50005	3580	30026	Slott.Rais.Counter.Head Screw M4x12 Din7985 A2 for 50005	4180
35346	Seal Beam DS/1/495 for 50005	3110	35372	Castle Washer M8 for 50005	3590	35381	Terminal Block 4-Pole for 50005	4200
62573	Sealbeam TS/1/495 for 50005	3120	35758	Hexagon Screw M8x60 Din933 A2 for 50005	3600	35382	Cover Connection Block 4-Pole for 50005	4210
62574	Sealbeam 8mm/1/495 for 50005	3130	27787	Hexagon Screw M6x16 DIN933 A2 for 50005	3650	35380	Slotted Cheese Head Screw M4x12 A2 Din84 for 50005	4220
15894	Seal Beam Single Seal L=800mm Complete for 50005	3140	35760	Spring Ring M6 Din127 A2 for 50005	3660	35782	Vac.Pump 063-122 230/400-3-50 E for 50005	5010
62575	Sealbeam DS/1/795 for 50005	3150	35507	Holing Block Silicon Holder HD-03 for 50005	3690	35388	Hose Clip ABA 32-44mm for 50005	5040
62576	Sealbeam TS/1/795 for 50005	3160	35364	O-Ring 27x2.5 for 50005	3700	15833	PVC Suction Hose HNA-32x42mm for 50005	5050
62577	Sealbeam 8mm/1/795 for 50005	3170	35365	Mounting Screw Holing Block HD-03 for 50005	3740	35390	Pipe Nipple Half 1/2 1" for 50005	5060
35742	Seal Beam DS/1/540 for 50005	3180	35764	Spacer Sil.Holder Gas 68mm for 50005	3750	35391	Adj.Screw/Soc.Head M8x25 Din916 A2 for 50005	5070
62578	Sealbeam TS/1/540 for 50005	3190	35765	Bottom Section SB-820 for 50005	4010	35219	Flat Washer M8 D9021 A2 for 50005	5080

PARTS BREAKDOWN

ITEM	MODEL
50005	VP-NL-0063-M

Item No.	Description	Position	Item No.	Description	Position	Item No.	Description	Position
27814	Hexagon Nut M8 Din934 A2 for 50005	5100	35403	Plastic Check Nut PG 16 for 50005	9090	35413	Elbow 1/4" Int Brass for 50005	9200
35394	Control 03-Turbovac Tested for 50005	9010	35404	Cover Control Box for 50005	9100	35414	Hose Pillar 1/4x4 BU R Norma for 50005	9210
35395	Control Turbovac Basic for 50005	9011	35571	Cross Recessed Raised Cheese Head Screw M3.5x10 for 50005	9110	35415	Plug Blac R5 for 50005	9310
35396	Packing Control + Glue-Layer for 50005	9020	35406	Cable Gland PG16 IP65 Plastic for 50005	9120	35416	Plug Blac R6 for 50005	9320
15780	Switch-Disconnecter Tripolar 25A Front for 50005	9040	35407	Sealing Washer 0-1/4 for 50005	9130	35417	Plug Blac R10 for 50005	9330
35398	Control Panel Holder Turbovac for 50005	9050	35408	Reducing Ring 1/4"x1/8" for 50005	9140	15712	Hydraulic Oil for 3-Phase Vacuum Pump (060510) for 50005	9400
35399	Upper Sticker Turbovac 03 for 50005	9051	27819	Square Hose Coupling 1/8"x6 Ext. for 50005	9150	35419	Sticker Tension + Warning for 50005	9420
35400	Packing Cover Control + Glue-Layer for 50005	9060	34998	Flat Washer M4 D9021 A2 Carriage Ring M4 for 50005	9160	27794	Sticker Machine Type for 50005	9430
30010	Brass Nut 1/4" for 50005	9070	35411	Hexagon Nut M4 Din934 A2 for 50005	9170	35223	Sticker 19x38 Yellow for 50005	9440
35402	Square Hose Coupling 1/8"x4 Ext. for 50005	9080	35579	Vacuum Meter 40mm for 50005	9190	35224	Sticker 98x65 Yellow for 50005	9450

WARRANTY REGISTRATION

Thank you for purchasing an Trento product. To register your warranty for this product, complete the information below, tear off the card at the perforation and then send to the address specified below. You can also register online by visiting:

Merci d'avoir acheté un produit Trento. Pour enregistrer votre garantie pour ce produit, complétez les informations ci-dessous, détachez la carte au niveau de la perforation, puis l'envoyer à l'adresse spécifiée ci-dessous. Vous pouvez également vous inscrire en ligne en visitant:

Gracias por comprar un producto Trento usted. Para registrar su garantía para este producto, complete la información a continuación, cortar la tarjeta en la perforación y luego enviarlo a la dirección indicada a continuación. También puede registrarse en línea en:

<https://omcan.com/warranty-registration/>

For mailing in Canada

Pour postale au Canada

Por correo en Canadá

For mailing in the US

Pour diffusion aux États-Unis

Por correo en los EE.UU.

TRENTO

PRODUCT WARRANTY REGISTRATION

3115 Pepper Mill Court,
Mississauga, Ontario
Canada, L5L 4X5

TRENTO

PRODUCT WARRANTY REGISTRATION

4450 Witmer Industrial Estates, Unit 4,
Niagara Falls, New York
USA, 14305

or email to: trentoservice@trentoequipment.com



Purchaser's Information

Name: _____

Address: _____

City: _____ Province or State: _____ Postal or Zip: _____

Country: _____

Dealer from which Purchased: _____

Dealer City: _____ Dealer Province or State: _____

Invoice: _____

Model Name: _____ Model Number: _____

Machine Description: _____

Date of Purchase (MM/DD/YYYY): _____

Would you like to extend the warranty? Yes No

Company Name: _____

Telephone: _____

Email Address: _____

Type of Company:

Restaurant Bakery Deli

Butcher Supermarket Caterer

Institution (*specify*): _____

Other (*specify*): _____

Serial Number: _____

Date of Installation (MM/DD/YYYY): _____

Thank you for choosing Trento | Merci d'avoir choisi Trento | Gracias por elegir Trento

TRENTO

ELEVATING CULINARY EXCELLENCE

TRENTO IS A SIGNATURE LINE OF PROFESSIONAL
RESTAURANT EQUIPMENT FROM OMCAN
OFFERING PREMIUM EUROPEAN BRANDS TO THE
NORTH AMERICAN MARKET.

Thank you for your purchase!



Follow us on social media
@trentoequipment

