

Parts Breakdown

Model FW-CN-0251 44181

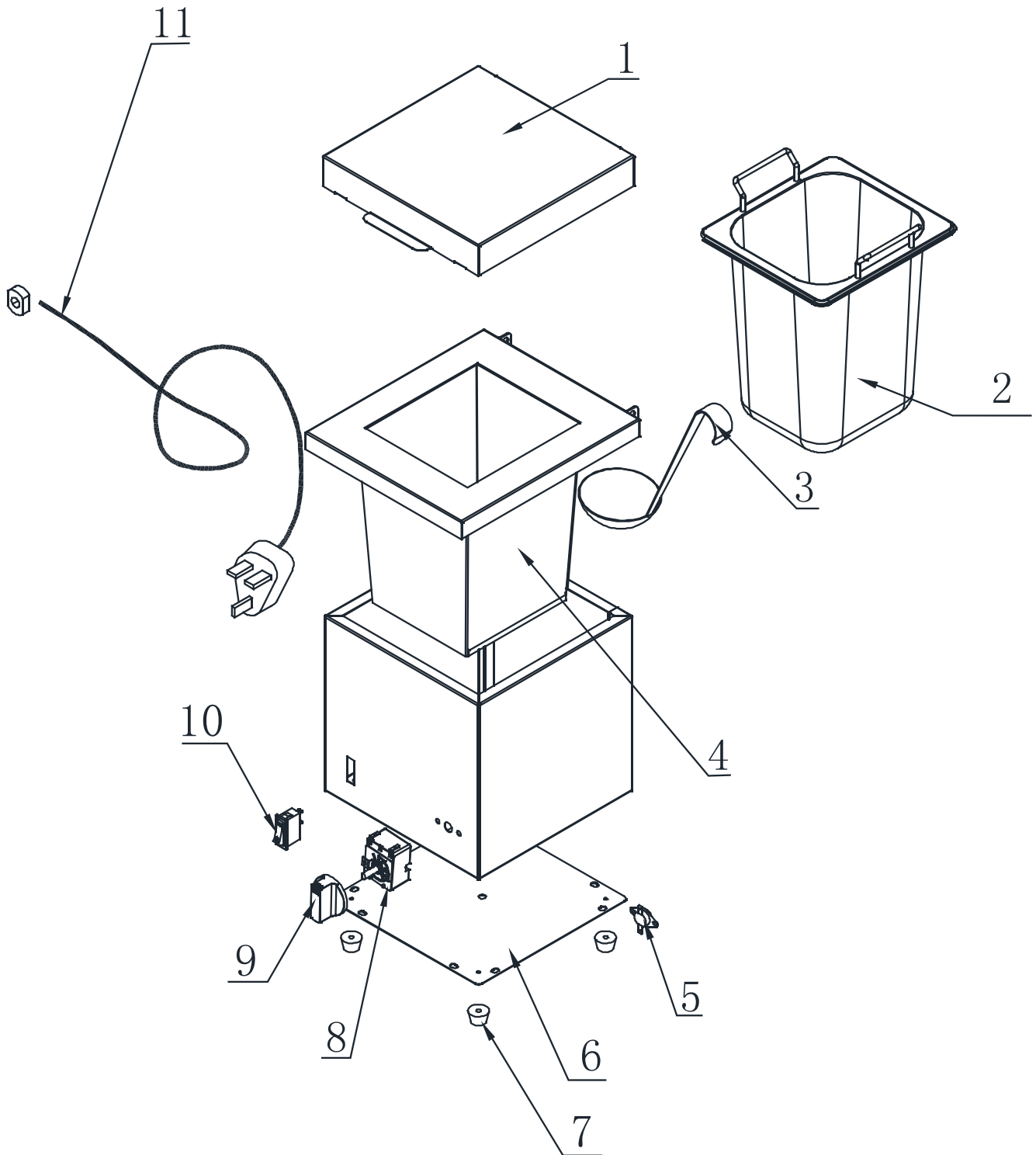



Parts Breakdown

Model FW-CN-0251 44181

Item No.	Description	Position	Item No.	Description	Position	Item No.	Description	Position
65021	Lid for 44181	1	65027	Thermal Cut Out for 44181	5	65033	Dial for 44181	9
65024	Pot with Handles for 44181	2	65028	Base for 44181	6	65034	Switch for 44181	10
65025	Spoon for 44181	3	65031	Feet for 44181	7	65035	Plug and Lead for 44181	11
65026	Element for 44181	4	65032	Thermostat for 44181	8			