

Parts Breakdown

Model **FR-TH-1524-HC** 58017

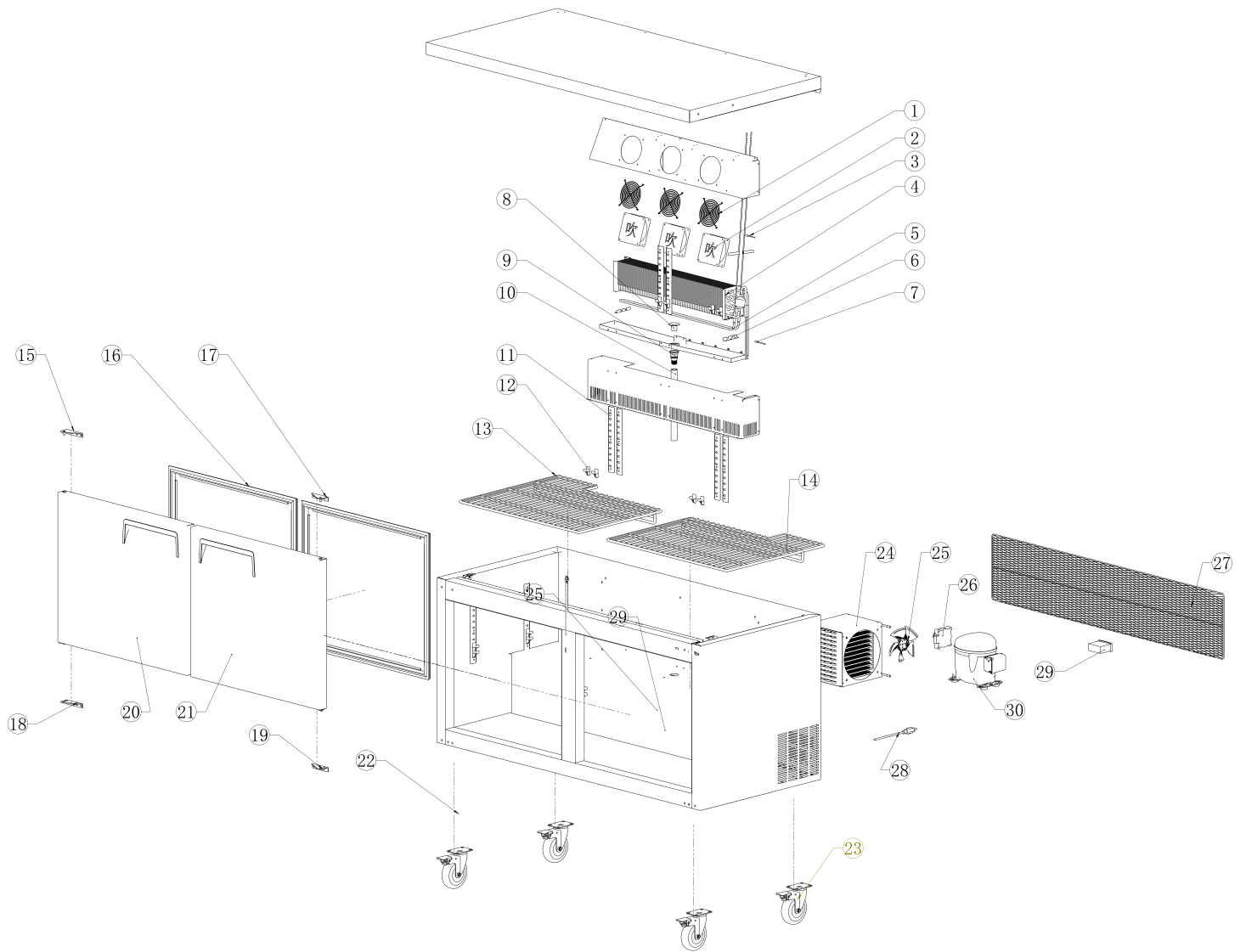

Parts Breakdown

Model FR-TH-1524-HC 58017

Item No.	Description	Position	Item No.	Description	Position	Item No.	Description	Position
AP919	Fan Stainless Steel Mesh Cover for 58017	1	AP929	Ladder Strip for 58017	11	AP975	Doors Assembly (Right) for 58017	21
AP920	Evaporator Motor for 58017	2	AP930	Grey K-Clip for 58017	12	AP936	Universal Wheel (with Brake) for 58017	22
AP921	Temperature Sensor Probe (Black) for 58017	3	AP971	Shelf (Left) for 58017	13	AP937	Universal Wheel (without Brake) for 58017	23
AP959	Evaporator for 58017	4	AP972	Shelf (Right) for 58017	14	AP966	Condenser (OD4.7x26110mm) for 58017	24
AP960	Frost Heating Tube for 58017	5	AP952	Top Hinge (Left) for 58017	15	AP939	Fan Blade (EBM) for 58017	25
AP924	Heating Tube Fixings for 58017	6	AP973	Gasket for 58017	16	AP940	Condenser Motor for 58017	26
AP925	Temperature Sensor Probe (White) for 58017	7	AP933	Top Hinge (Right) for 58017	17	AP976	Mesh Plate (-AU09) for 58017	27
AP926	Drainage Outlet - Top for 58017	8	AP954	Bottom Hinge (Left) for 58017	18	AP942	Power Cable (Black) for 58017	28
AP927	Drainage Outlet - Bottom for 58017	9	AP934	Bottom Hinge (Right) for 58017	19	AP943	Controller (Dixell) 115V/60Hz for 58017	29
AP928	Outside Drain Pipe for 58017	10	AP974	Doors Assembly (Left) for 58017	20	AP968	Compressor (NPY12LR; 115-127V~60Hz R290) for 58017	30