

INSTRUCTION MANUAL

Band Saws

Item	45507
Model	BS-IT-1829-L



Warning!

Before you begin using your appliance, **PLEASE READ AND UNDERSTAND THIS DOCUMENT CAREFULLY** before installing, operating, maintaining, or servicing.

There are many important safety messages in this manual and on your appliance. Always read all safety messages.

Failure to do so can result in appliance failure, property damage, serious injury or death. Appliance failure, injury or property damage due to improper installation is not covered by warranty.

Stop!

DO NOT RETURN THIS PRODUCT TO THE STORE!

For questions or assistance with this product, call TRENTO Toll free: **1-800-465-0234** or visit the support section from our website, **www.trentoequipment.com**

Version: Revised - 03/15/2024



TABLE OF CONTENTS

Section	Section
General Information -----	3 - 4
Safety and Warranty -----	4 - 7
Technical Specifications -----	8 - 9
Installation -----	10 - 14
Operation -----	15
Maintenance -----	16 - 17
Troubleshooting -----	17 - 20
Parts Breakdown -----	21 - 23
Electrical Schematics -----	24
Notes -----	25 - 26
Warranty Registration -----	27

GENERAL INFORMATION

Omcan Manufacturing and Distributing Company Inc., Food Machinery of America, Inc. dba Omcan and Omcan Inc. are not responsible for any harm or injury caused due to any person's improper or negligent use of this equipment. The product shall only be operated by someone over the age of 18, of sound mind, and not under the influence of any drugs or alcohol, who has been trained in the correct operation of this machine, and is wearing authorized, proper safety clothing. Any modification to the machine voids any warranty, and may cause harm to individuals using the machine or in the vicinity of the machine while in operation.

CHECK PACKAGE UPON ARRIVAL

Upon receipt of an Omcan shipment please inspect for external damage. If no damage is evident on the external packaging, open carton to ensure all ordered items are within the box, and there is no concealed damage to the machine. If the package has suffered rough handling, bumps or damage (visible or concealed), please note it on the bill of lading before accepting the delivery and contact Omcan within 24 hours, so we may initiate a claim with the carrier. A detailed report on the extent of the damage caused to the machine must be filled out within three days, from the delivery date shown in the shipping documents. Omcan has no recourse for damaged products that were shipped collect or third party.

Before operating any equipment, always read and familiarize yourself with all operation and safety instructions.

Omcan would like to thank you for purchasing this machine. It's of the utmost importance to save these instructions for future reference. Also save the original box and packaging for shipping the equipment if servicing or returning of the machine is required.

Omcan Fabrication et distribution Compagnie Limitée et Food Machinery d'Amérique, dba Omcan et Omcan Inc. ne sont pas responsables de tout dommage ou blessure causé du fait que toute personne ait utilisé cet équipement de façon irrégulière. Le produit ne doit être exploité que par quelqu'un de plus de 18 ans, sain d'esprit, et pas sous l'influence d'une drogue ou d'alcool, qui a été formé pour utiliser cette machine correctement, et est vêtu de vêtements de sécurité appropriés. Toute modification de la machine annule toute garantie, et peut causer un préjudice à des personnes utilisant la machine ou des personnes à proximité de la machine pendant son fonctionnement.

VÉRIFIEZ LE COLIS DÈS RÉCEPTION

Dès réception d'une expédition d'Omcan veuillez inspecter pour dommages externes. Si aucun dommage n'est visible sur l'emballage externe, ouvrez le carton afin de s'assurer que tous les éléments commandés sont dans la boîte, et il n'y a aucun dommage dissimulé à la machine. Si le colis n'a subi aucune mauvaises manipulations, de bosses ou de dommages (visible ou cachée), notez-le sur le bond de livraison avant d'accepter la livraison et contactez Omcan dans les 24 heures qui suivent, pour que nous puissions engager une réclamation auprès du transporteur. Un rapport détaillé sur l'étendue des dommages causés à la machine doit être rempli dans un délai de trois jours, à compter de la date de livraison indiquée dans les documents d'expédition. Omcan n'a aucun droit de recours pour les produits endommagés qui ont été expédiés ou cueillis par un tiers transporteur.

Avant d'utiliser n'importe quel équipement, toujours lire et vous familiariser avec toutes les opérations et les

GENERAL INFORMATION

consignes de sécurité.

Omcan voudrais vous remercier d'avoir choisi cette machine. Il est primordial de conserver ces instructions pour une référence ultérieure. Également conservez la boîte originale et l'emballage pour l'expédition de l'équipement si l'entretien ou le retour de la machine est nécessaire.

Omcan Empresa De Fabricacion Y Distribucion Inc. Y Maquinaria De Alimentos De America, Inc. dba Omcan y Omcan Inc. no son responsables de ningun daño o perjuicio causado por cualquier persona inadecuada o el uso descuidado de este equipo. El producto solo podra ser operado por una persona mayor de 18 años, en su sano juicio y no bajo alguna influencia de droga o alcohol, y que este ha sido entrenado en el correcto funcionamiento de esta máquina, y ésta usando ropa apropiada y autorizada. Cualquier modificación a la máquina anula la garantía y puede causar daños a las personas usando la máquina mientras esta en el funcionamiento.

REVISE EL PAQUETE A SU LLEGADA

Tras la recepcion de un envio Omcan favor inspeccionar daños externos. Si no hay daños evidentes en el empaque exterior, Habra el carton para asegurarse que todos los articulos solicitados estén dentro de la caja y no encuentre daños ocultos en la máquina. Si el paquete ha sufrido un manejo de poco cuidado, golpes o daños (visible o oculto) por favor anote en la factura antes de aceptar la entrega y contacte Omcan dentro de las 24 horas, de modo que podamos iniciar una reclamación con la compañía. Un informe detallado sobre los daños causados a la máquina debe ser llenado en el plazo de tres días, desde la fecha de entrega que se muestra en los documentos de envío. Omcan no tiene ningun recurso por productos dañados que se enviaron a recoger por terceros.

Antes de utilizar cualquier equipo, siempre lea y familiarizarse con todas las instrucciones de funcionamiento y seguridad.

Omcan le gustaría darle las gracias por la compra de esta máquina. Es de la mayor importancia para salvar estas instrucciones para futuras consultas. Además, guarda la caja original y el embalaje para el envío del equipo si servicio técnico o devolución de la máquina que se requiere.

SAFETY AND WARRANTY

READING AND UNDERSTANDING THIS HANDBOOK

WARNING! Do not use the machine before you have read and understood this handbook, the warnings and/or all diagrams for the machine. Read and fully understand any additions, corrections and any other information, instruction, explanation which Omcan Inc. and/or their technical and commercial network will give you in any way (e-mail, fax, website, letter).

WARNING! Do not use the machine for purposes other than what is stated in this handbook and/or in the

SAFETY AND WARRANTY

warnings and/or in diagrams on the machine. Using the machine for purposes other than those stated in the manual may cause injury or damage to the machine.

- Omcan Inc. and the dealer cannot be held responsible for the consequences stemming from behaviors which do not conform with those listed in this manual and/or warnings and/or diagrams of the machine.
- Not complying with the instructions indicated in this manual and/or warnings and/or diagrams for the machine ends any warranty and can also have legal repercussions in case of accident.

WARNING! Do not alter the machine and its assembly system in any way.

WARNING! Never damage or alter any component of the machine, both general and specific safety components, are directly or indirectly necessary for your safety.

WARNING! Any use not explicitly allowed by Omcan Inc. is absolutely forbidden and may cause injury or damage; therefore, it is in breach of safety rules and transfers liability to both the person who gives the instruction and the person who carries it out.

WARNING! Although several safety measures are in place, there are dangers which cannot be totally reduced through the design and the safeguarding techniques. Such dangers are called “non-eliminable residual hazards” and are dangerous to the operator: therefore, carefully read and understand this handbook and all the warnings and the diagrams for the machine. It is mandatory and recommended to follow all instructions, with no exceptions.

The machine must not be used by persons under age of 18 (eighteen). The use of the machine is forbidden to people with physical or mental disabilities as the machine is designed to be exclusively used by people who are fully capable to use the machine. People with stress or physical/mental weakening, should not use the machine for the safety all persons around the machine. People under the effect of alcohol, psychotrope drugs, narcotics (soft and heavy drugs) must not use or be in the vicinity of the machine. The machine has to be used by one (1) operator who is well-acquainted with its functioning. Operation of the machine is to carried out by only one person. The machine is not designed to be used by persons who are not qualified or trained, therefore all activities have to be performed only by professional staff properly trained and qualified: use and maintenance for butchers; repairs carried out by technicians; dismissal by relevant operators. If the machine is not being used for extended period of time (examples: end of shift; weekend; holidays, bank holidays and permissions; absence for any reason), never leave it switched on and connected to the power line though the drive is not running, to avoid the useless consumption of power and for safety reasons. Omcan Inc. is not responsible for the actions mentioned above and the person in charge of the machine must take care of them. At the end of each shift, the machine has to be switched off and put in the emergency state by pushing the red push button. If the control board is equipped with a safety key for the startup (optional component), the operator must remove this key. The machine must never be used by persons who have not been trained and who are not formally authorized to operate this machine. If the operator is not trained, the supervision of a qualified operator is necessary. Remind anyone using the machine that they must use the machine safely and carefully to avoid accidents and increase working safety. The machine is supplied with guards and safety devices which must not be removed or modified; the person in charge of safety and the machine operator must supervise so that the machine is always equipped with original guard.

SAFETY AND WARRANTY



PERSONAL PROTECTIVE EQUIPMENT

PERSONAL PROTECTIVE EQUIPMENT IN CONFORMITY WITH CURRENT RULES: all of the following personal protective equipment (PPE) has to be in conformity with relevant technical rules in force (Directive no. 89/656/CEE and following amendments and updates) and therefore has to be EC-marked and have relevant declaration of conformity which usually refers to specific European (EN) technical rules of the harmonized type. The operators must always inform the employer, manager and/or representative of the anomalies in the operation or characteristics of the use of their personal protective equipment.

HEAD: the use of a cap to keep the hair gathered is mandatory in order to avoid entanglement with the moving elements; for hygienic reasons, the cap must always be clean and must be able to retain the hair of the operators. The hair might get entangled and cause serious accidents.

EYES: to protect the eyes from bone splinters and/or accidental blade breaking, wear safety glasses.

NOSE, MOUTH: to protect the respiratory tract from toxic or dangerous emissions of meat and similar substances, it is mandatory to wear filtering masks; they have to be replaced with signs of dirt or partial clogging; they have to be replaced after 2 (two) working days.

EARS: the machine does not produce a loud noise and it produces a continuous level of acoustic pressure equivalent weighted "A" of 82 dB(A) \pm 1 dB(A) vacuum and of 88 dB(A) \pm 1 dB(A) when dry cutting large and strong bones; thus ear protectors (protective headset) are strongly recommended and workers must be instructed on their correct use. The use of new blades or very sharp blades and water-lubrication of the cutting area of bones contribute to reducing the noise. The length of exposure to the noise is also a hazard. Submit workers to regular health checks.

LIMBS AND BODY (what not to do): never wear rings, wrist watches, bracelets, jewelry, torn clothing or those with loose parts, scarves, ties, loose belts as they might get entangled and cause serious injury.

LIMBS AND BODY (what to do): for the protection of body parts, always wear overalls or coats with elastic cuffs; both have to be worn well tight, without leaving them open, only partially tightened or with loose parts; tighten the sleeves around the cuffs and always keep your hair gathered in a cap.

FEET: it is mandatory to wear safety shoes with steel tips to protect the feet from the fall of heavy objects (the machine itself or its spare parts or large pieces of food).

SAFETY AND WARRANTY

HANDS: to protect your hands, wear mesh protective gloves to replace the BLADES ONLY. **Make sure that the machine is off and power has been disconnected before changing the blades.**

RESIDENTIAL USERS: vendor assumes no liability for parts or labor coverage for component failure or other damages resulting from installation in non-commercial or residential applications. The right is reserved to deny shipment for residential usage; if this occurs, you will be notified as soon as possible.

1 YEAR PARTS AND LABOUR WARRANTY

Within the warranty period, contact Omcan Inc. at 1-800-465-0234 to schedule an Omcan authorized service technician to repair the equipment locally.

Unauthorized maintenance will void the warranty. Warranty covers electrical and part failures, not improper use.

Please see <https://omcan.com/disclaimer> for complete info.

WARNING:

The packaging components (cardboard, polyethylene, and others) are classified as normal solid urban waste and can therefore be disposed of without difficulty.

In any case, for suitable recycling, we suggest disposing of the products separately (differentiated waste) according to the current norms.

DO NOT DISCARD ANY PACKAGING MATERIALS IN THE ENVIRONMENT!

TECHNICAL SPECIFICATIONS

Item Number	45507
Model	BS-IT-1829-L
Blade Length	72" / 1830mm
Cutting Capacity	10.6" x 8.3" / 270 x 210mm
Power	1.2 HP / 0.9 kW
Current	12.5 A
Electrical	110-120V / 60Hz / 1
Net Weight	79.4 lbs. / 36 kgs.
Packaging Weight	88.2 lbs. / 40 kgs.
Net Dimensions (DWH)	18.5" x 21.3" x 35" / 470 x 540 x 890mm
Packaging Dimensions	36.2" x 18.1" x 16.5" / 920 x 460 x 420mm

TECHNICAL SPECIFICATIONS

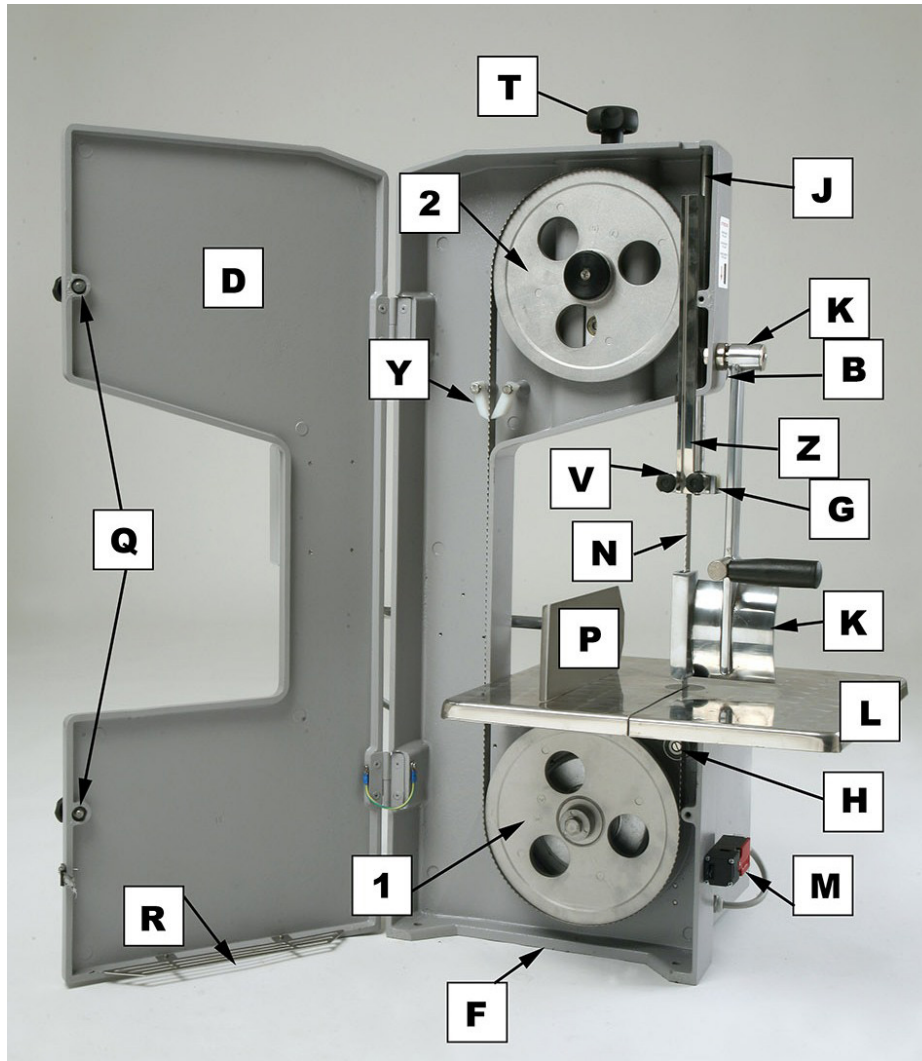

B) BLADE GUIDE BLOCK KNOB.	K) OPTIONAL ONLY FALLING MEAT PUSHER.	T) BLADE TENSION KNOB.
C) MACHINE BODY.	L) WORKING TABLE.	V) BLADE GUIDE SCREWS.
D) DOOR.	M) MICROSWITCH.	Y) SLIDING BLOCKS FOR SAW BLADE CLEANING.
F) EXIT WASTE OPENING.	N) SAW BLADE.	Z) BLADE PROTECTOR.
C) BLADE GUIDE.	P) PORTION DEVICE.	1) DRIVING PULLEY.
H) SAW BLADE THRUST BEARING.	Q) DOOR LOCKING KNOB SCREWS.	2) PULLEY PATH.
J) BLADE GUIDE.	R) METALLIC GRID PROTECTION AGAINST ACCESS TO BLADE AND PULLEY FROM EXIT WASTE OPENING.	

INSTALLATION

A space of at least 100 cm (39.37") has to be left around each side of the machine to avoid hazards, falling of the machine, to easily perform cleaning and maintenance and to avoid difficulty when using with pieces of meat. The floor must be a non-slip surface and has to be always kept clean.

The machine has to be assembled on a flat, level surface (or onto a very stable pedestal) having a height ranging from at least 45 cm (17.72") and not exceeding 69 cm (27.17") from ground so that the working table upper surface is at a height from the ground ranging from 80 cm (31.50") to 105 cm (41.34"). Then, the electrical assembly has to be carried out.

After the installation, make sure that no one touches the machine and connect the feeding plug to a socket (110-120V ~ 60 Hz for single-phase motor machines).

- To switch the machine on, turn clockwise the rotational device towards "I" = ON = switched ON.
- To switch the machine off, turn counterclockwise the rotational device towards "O" = OFF = switched OFF.



Check the correct rotation of the motor and blade running direction, which always goes from upwards to downwards. Check that (both when the motor is running and when it is idle, but the machine is powered) the efficiency of the connection and protection of the electrical switchboard have been performed. If such checks are passed, the machine is electrically installed; if they are not, contact Omcan Inc. or the dealer for maintenance.

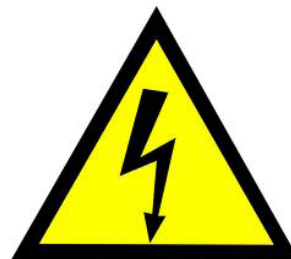

INSTALLATION

BLADE GUIDE SLIDING BLOCKS ADJUSTMENT

1. Make sure that the machine is switched off (rotational device positioned "O" = OFF).
2. Make sure that the machine is not working (blade has stopped).
3. Unscrew any of the two black (M) small knobs while paying attention not to unscrew it completely from its seat (S).
4. Bring the white sliding block (P) close to the blade (L) until they are very close.
5. Evaluate the thickness of the sliding block (the sliding blocks of the blade guide are open to continuous wear; therefore they have to be replaced when their thickness is below 1.5 cm) and, if necessary, replace it with a new sliding block.
6. Re-screw the small knob (M) to lock the sliding block (P).
7. Repeat the operations from 1 to 6 for the other sliding block.

[K] OPTIONAL ONLY falling meat pusher.

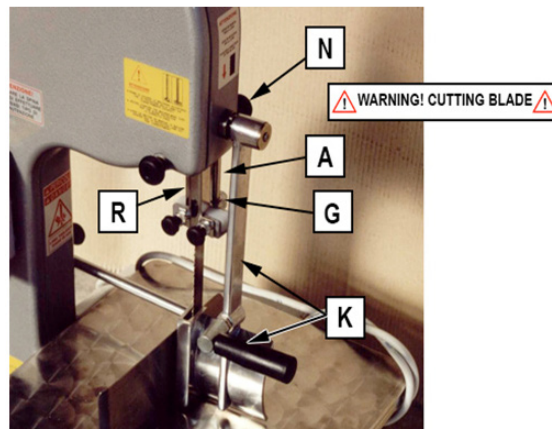

INSTALLATION

BLADE GUIDE HEIGHT ADJUSTMENT

1. Make sure that the machine is switched off (rotational device positioned "O" = OFF).
2. Make sure that the machine is not working (blade has stopped).
3. Unscrew the black knob (N) (located opposite to the working table of the operator) which, through its integral screw, blocks the rod (A) of the blade guide (G) coming out from machine upper part and the working table; in this way, the rod (A) of the blade guide (G) can run vertically.
4. Adjust the height of the blade guide (G) according to the height of the material to cut (max. 1 cm above it).
5. Screw the small knob (N) to block the rod (A) of the blade guide (G), the blade guide (G) and the protection (R) necessary to them, at the desired height.

[K] OPTIONAL ONLY falling meat pusher.

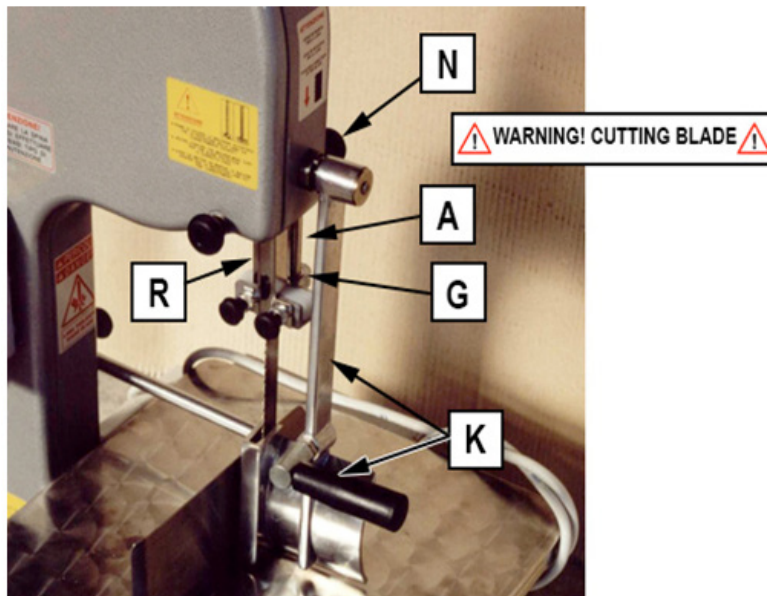

INSTALLATION

BLADE TENSION ADJUSTMENT

1. Make sure that the machine is switched off (rotational device positioned "O" = OFF).
2. Make sure that the machine is not working (blade has stopped).
3. Screw the black knob (T) located on top to increase the blade tension and unscrew to decrease the blade tension; it is not necessary to open the door or unscrew the pulley to perform such adjustment.
4. Screw the black knob (T) so that the white line on the neck of the button is very close to the frame of the bone band saw (as per photo of the back side of the bone band saw).
5. Always check the blade tension when the machine is not working before restarting it (before restarting the motor).

(K) OPTIONAL ONLY falling meat pusher.

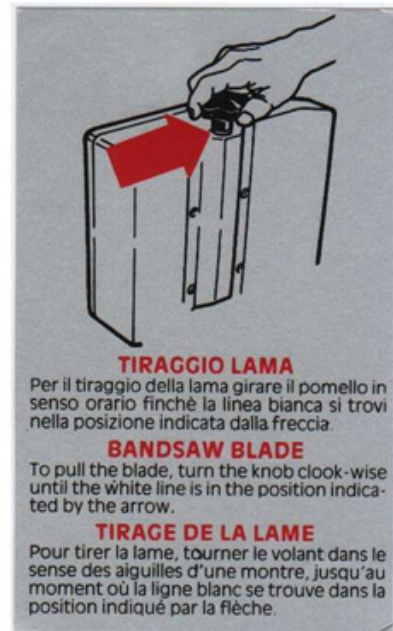
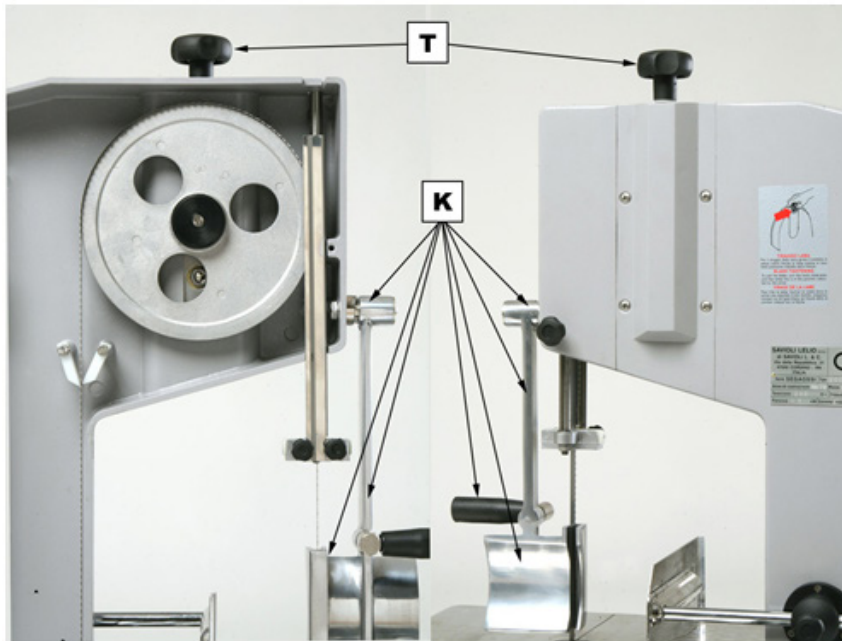

BLADE REPLACEMENT

1. Make sure that the machine is switched off (rotational device positioned "O" = OFF).
2. Make sure that the machine is not working (blade has stopped).
3. Open the door (H) at least 90°.
4. Disassemble the protection device (R) from the blade necessary to the blade guide (G).
5. Unscrew the black knob (T) located on the top to decrease the interaxle between the two pulleys and reduce the tension of the blade until it easily and manually comes out from pulleys.
6. Extract the blade from the pulleys making sure not to hurt yourself (do not work with bare hands, use the prescribed protective gloves) and put it in a safe place not accessible to children or non-trained personnel.
7. Insert a new blade in the pulleys making sure not to hurt yourself (do not work with bare hands, use the prescribed protective gloves) inserting it in the pulleys by shifting it as opposed to those performed to draw it out.

INSTALLATION

8. Check the correct positioning of the new blade on the two pulleys.
9. Screw the black knob located on the top to increase the interaxle between the two pulleys and increasing the tension of the blade up to the desired value. It should be tight enough so that the blade cannot be extracted from the pulleys from pulling on it.
10. Re-assemble and adjust the protection device (R) of the blade necessary to the blade guide.
11. Close the door (H) towards the framework body (C).

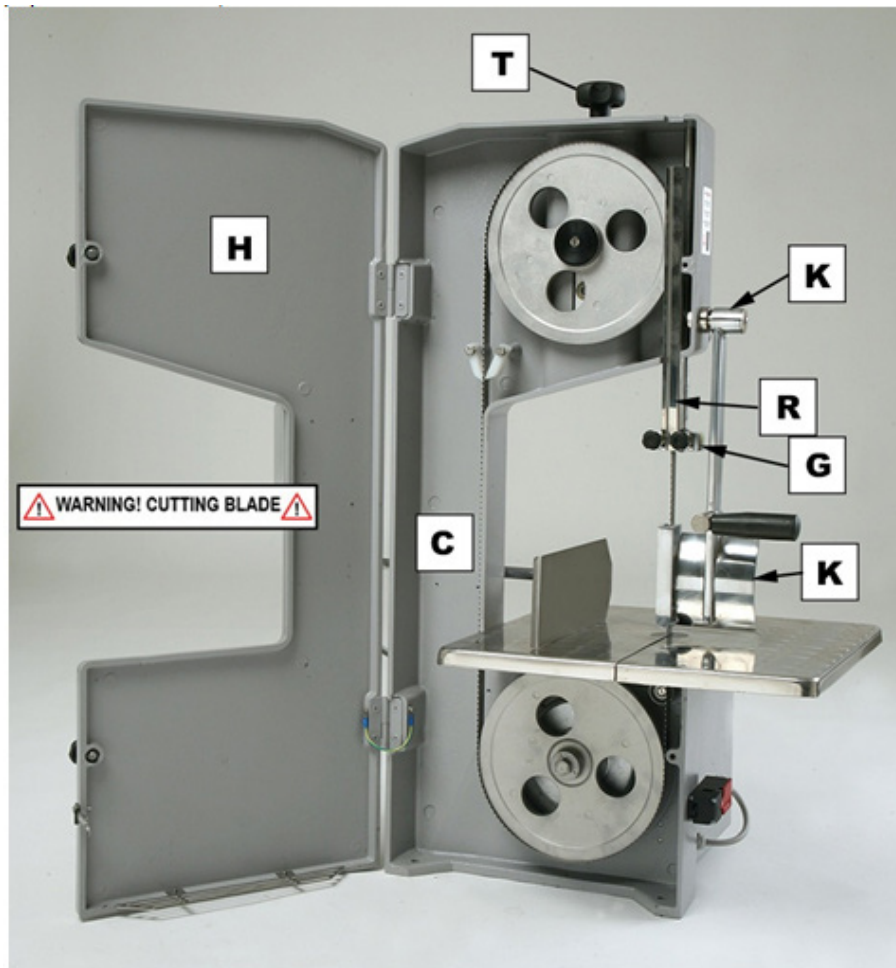

OPERATION

1. Make sure that the machine is switched off (rotational device positioned "0" = OFF).
2. Make sure that the machine is not working (blade has stopped).
3. Put the material to cut on the working table.
4. Adjust the height of the blade guide according to the height of the material to cut.
5. Adjust the lateral position and leave a space similar to the thickness of the product between it and the saw blade.
6. Bring the material to cut in contact with the portioning device.
7. **NOTE:** It is forbidden to cut materials such as wood, plastic, paving tiles, bricks, stones, glass, metals, leather, cardboard, fabrics, etc. even though a specific blade for this aim is available.
8. To cut other slices having the same thickness, go back to 6.
9. To cut other slices having a different thickness, go back to 5.
10. If the height of the material to cut varies of more than 1 cm when cutting more slices, go back to 1.



CUTTING FROZEN PRODUCT

These machines can be used to cut frozen product by following the below recommendations:

- To cut frozen fish, we recommend to use a saw blade of 20 mm width and 3 teeth per inch.
- To cut frozen bones, we recommend to use a saw blade of 20 mm width and 4 teeth per inch.

Additional blades can be purchased from Omcan.

MAINTENANCE

WARNING! Before any cleaning and/or maintenance and/or check, switch the machine off (rotational device positioned "O" = OFF) and then disconnect the power cord from the socket. Cleaning, maintenance or checks must be performed when the machine is not connected to the power source.

Before restarting the machine, make sure that no one is touching it. The use and the regular cleaning of the machine reduce the need for extraordinary maintenance and repair; the daily cleaning of the machine is an important factor to promptly detect possible defects or damages. At least once a week, clean the machine with a soft and dry cloth which does not lose its fabric. Avoid using petrol, solvents or any other type of detergent on the non-metallic parts which can be exclusively cleaned with a neutral and non-foamy water-based detergent. Never use abrasive products, chlorate substances, wire wools, brushes of any type, scrapers, etc., only use small brushes having rigid bristles and cloths which do not lose fabrics, fibers or fragments.

WARNING! The machine must never be washed with water jets (without buckets, rubber hoses or sponges).

WARNING! The machine does not need lubrication or greasing since it is equipped with self-lubricating bearings.

WARNING! After a thorough visual check at the beginning of each shift, make sure:

- The inside of the machine is clean while playing close attention to the pulleys; if necessary, clean and sanitize them.
- The cleanness of the lower container gathering the processed waste; if necessary, clean and sanitize it.
- The condition of the power cable and its plug.
- The condition of the switchboard and the control buttons (check whether there are cracks, splintering, scratches, distortions, cuts, etc.).
- The working of all safety devices: the rotational device positioned "O" = OFF and door interblock microswitch; then all the remaining safety devices already listed.

If damaged or bad working components are detected, do not allow anyone to use the machine and put a warning about such prohibition; then contact the dealer or Omcan Inc. for maintenance.

STORAGE AND DISPOSAL

In order to preserve the machine (which is off) for a very long period the following rules must be abided by:

- Disconnect the power cable from the socket.
- Do not lay on the machine any other object and make sure that the place of storage is dry, not humid, dust free, clean and free from insects or other animals and protected against bad weather conditions or other agents (for example, atmospheric agents, drops of water or other liquids, pollution) which might damage it; the place must not be subject to considerable temperature ranges.
- Abide by all technical specifications indicated earlier in this operating handbook.
- If the original packing is still available, put the machine into it or cover it with a piece of cloth of nylon, cellophane, polyethylene or other material of suitable size and if possible package it firmly to avoid the machine being damaged due to falls or damage by other materials which might enter into contact with it.

MAINTENANCE

It is also forbidden to leave or dispose the machine or any of its parts in the environment. It is also forbidden to dispose there is still solid urban waste; if the machine is no longer used, deliver it to qualified disposal facilities or authorized dealers.



TROUBLESHOOTING

PROBLEM	POSSIBLE CAUSES	SOLUTIONS
Machine does not start.	Lack of power from the electrical network.	Restore the supply of power from the electrical network.
	Electrical network's ON/OFF is in "O" position, OFF.	Turn the ON/OFF switch of the electrical network to "I" position, ON.
	Machine's ON/OFF switch in "O" position.	Turn the ON/OFF switch to "I" position.
	Damaged ON/OFF switch.	Contact the manufacturer to have the ON/OFF switch replaced and check the electrical parameters (V, A, cos Φ).

TROUBLESHOOTING

Machine does not stop.	Machine ON/OFF switch in "I" position.	Turn the ON/OFF switch to "O" position.
	Damaged ON/OFF switch.	Turn the ON/OFF switch to "O" position and contact the manufacturer or dealer to have the ON/OFF switch repaired.
Door is open but the machine does not stop.	Damaged door safety microswitch.	Contact Omcan or the dealer to have the door safety microswitch replaced.

TROUBLESHOOTING

The machine is noisy (vibration, creaking, whistling, etc.).	The working table or one of the supports which do not touch the ground.	Add some shims under the working table or adjust the supports so that they are all flat.
	One or two supports of the machine do not lay properly on the working table.	Adjust the machine supports so that all lay flat.
	Saw blade is too slow or too tight.	Check the pulleys and the tension of the feeding band and adjust it through the upper black knobs.
	One or both pulleys are damaged or out of their axis.	Check the condition of the pulleys and if they are out of axis or not properly fixed, contact Omcan Inc. or the dealer to have them repaired.
	The door is not properly closed.	Check door hinges and relevant locking screws and, if necessary, screw them in.
	The safety microswitch is not properly fixed.	Check the safety microswitch locking screws and, if necessary, screw them.
	The sliding blocks of the blade guide are too tight on saw blade.	Adjust the sliding blocks slightly taking them away from the blade. See above on how to adjust the sliding blocks.
	Saw blade has damaged tothing.	Replace the saw blade with a new one. Ensure it is an original spare part.
	Saw blade with tothing unsuitable for the material to cut.	If the material to cut is among those envisaged for the machine, contact Omcan Inc. or the dealer to have a saw blade suitable for the material to cut, otherwise read below.
	Material to cut is too hard.	Avoid trying to cut such material since it is not included in the list supplied by Omcan Inc.
Material to cut is not included among those envisaged by Omcan Inc.	Avoid trying to cut such material since it is not included in the list supplied by Omcan Inc.	

TROUBLESHOOTING

The saw blade coming out from the pulleys.	Saw blade is too slow or too tight.	Check the pulleys and the tension of the feeding band and adjust it through the upper black knobs.
	One or both pulleys are damaged or out from their axis.	Check the pulleys and contact Omcan Inc. or the dealer to have them repaired if they are out of their axis.
	Bad quality of blade.	Replace the saw blade with a new one. Ensure it is an original spare part.
Considerable heating of the saw blade.	Loss of sharpening of the saw blade.	Replace the saw blade with a new and original one.
	Waste clogged between blade and blade guide.	Disassembly and thoroughly clean the blade guide and then reassemble it.
	Bearings of one or both pulleys are damaged or blocked.	Contact Omcan Inc. or the dealer to replace the bearings.
Cutting is not perfect.	Saw blade is too slow or too tight.	Check the pulleys and the tension of the feeding band and adjust it through the upper black knob if it differs from the relevant values.
	Loss of sharpening of the saw blade.	Replace the saw blade with a new one. Ensure it is an original spare part.

PARTS BREAKDOWN

ITEM	MODEL
45507	BS-IT-1829-L

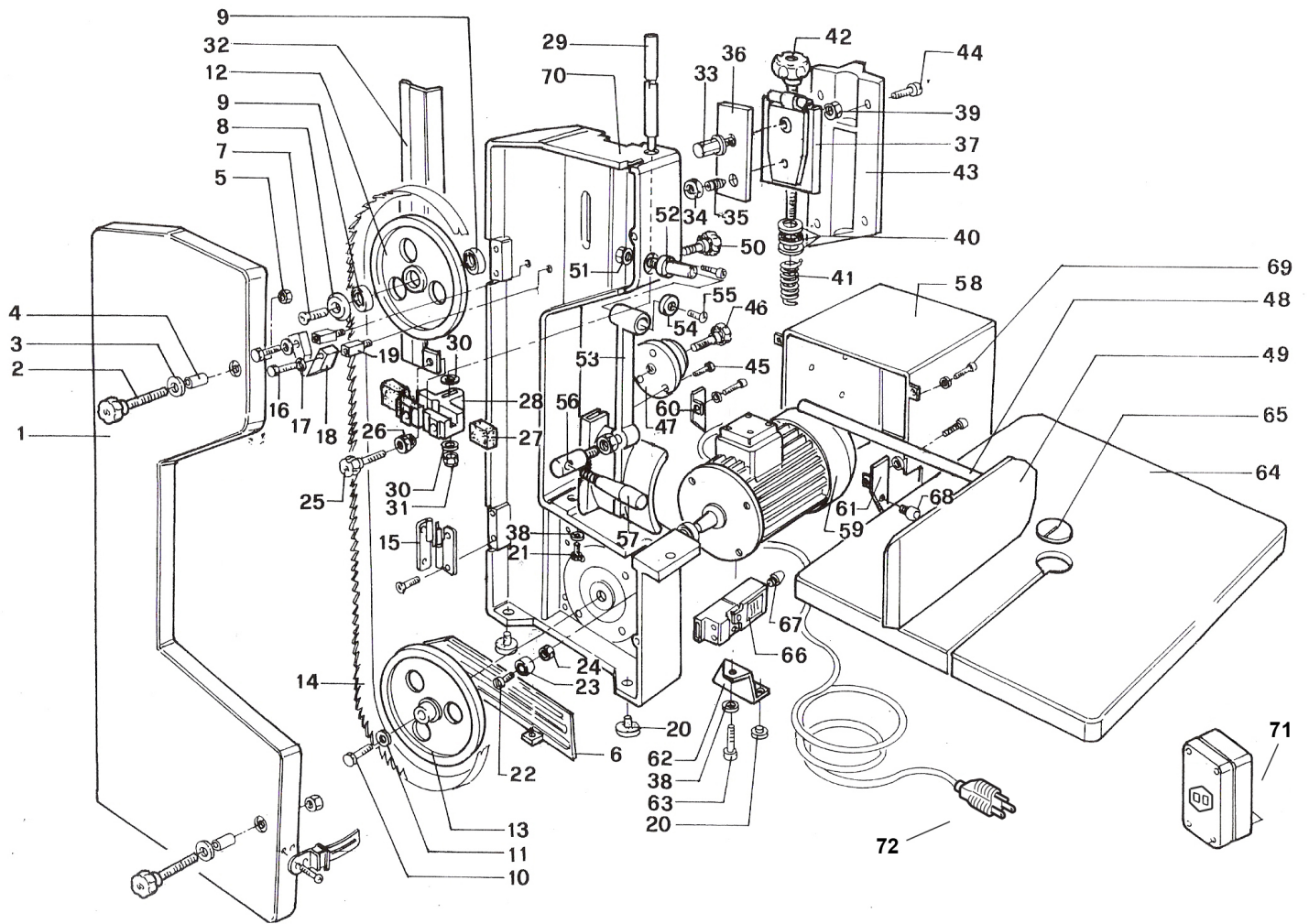

PARTS BREAKDOWN

ITEM	MODEL
45507	BS-IT-1829-L

Item No.	Description	Position	Item No.	Description	Position
34915	Door for 45507	1	34942	Washer for 45507	30
34916	Knob to Close the Opening for 45507	2	34943	Nut for 45507	31
34917	Washer for 45507	3	19953	Blade Protection for 45507	32
34918	Brass Closing Screw for 45507	4	34944	Upper Fly-Wheel Pivot for 45507	33
34919	Nut for 45507	5	34945	Nut for 45507	34
34920	Lower Protection for 45507	6	34946	Adjustment Fly-Wheel Screw for 45507	35
34921	Upper Fly-Wheel Screw for 45507	7	34947	Lamination for 45507	36
34922	Screw to Protect from Dust for 45507	8	34948	Slide for 45507	37
34923	Bearing 6203 2RS for 45507	9	34949	Washer for 45507	38
34924	Lower Fly-Wheel Screw for 45507	10	34950	Nut for 45507	39
34925	Screw for 45507	11	34951	Tension Grip Bearing for 45507	40
19950	Upper Fly-Wheel for 45507	12	34952	Tension Grip Spring for 45507	41
19951	Lower Fly-Wheel for 45507	13	34953	Tension Grip Knob for 45507	42
10328	72 Band Saw Blade 322 for 45507	14	34954	Opening for 45507	43
34927	Hinge for 45507	15	34955	Screw for 45507	44
34928	Screw for 45507	16	34956	Screw to Support Cutting Guide for 45507	45
34929	Washer for 45507	17	34957	Knob to Support Guide for 45507	46
34930	Shavehook for 45507	18	34958	Cutting Guide Support for 45507	47
34931	Shavehook Pivot for 45507	19	34959	Cutting Guide Pole for 45507	48
34932	Rubber Foot for 45507	20	34960	Cutting Guide (Height 105mm) for 45507	49
34933	Screw to Fase the Working Surface for 45507	21	34961	Knob of the Transporter Guide Pole for 45507	50
34934	Bearing Pivot for 45507	22	34962	Nut for 45507	51
34935	Bearing to Control the Push for 45507	23	34963	Pivot Meat Pusher for 45507	52
34936	Nut for 45507	24	34964	Meat Pusher for 45507	53
34937	Knob - Blade Guide for 45507	25	34965	Washer for 45507	54
34938	Blade Guide Ring Nut in Aluminum for 45507	26	34966	Screw for 45507	55
34939	Blade Guide Plug for 45507	27	34967	Connection of Knob Meat Pusher for 45507	56
34940	Blade Guide in Aluminum for 45507	28	34968	Knob Meat Pusher for 45507	57
34941	Blade Guide Pole for 45507	29	34969	Motor Cover for 45507	58

PARTS BREAKDOWN

ITEM	MODEL
45507	BS-IT-1829-L

Item No.	Description	Position	Item No.	Description	Position
34970	Motor for 45507	59	34976	Cable Closer PG 11 for 45507	67
34973	Motor Support for 45507	62	34978	Screw for 45507	69
34974	Screw for 45507	63	34979	Housing for 45507	70
34975	Meat Table for 45507	64	44776	New Style Rotary Switch and Safety Relay and Box for 45507	71
17853	Bakelite Plate for 45507	65	34981	Power Cord for 45507	72
19954	Microswitch for 45507	66			

ELECTRICAL SCHEMATICS

ITEM	MODEL
45507	BS-IT-1829-L

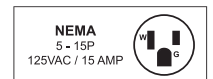
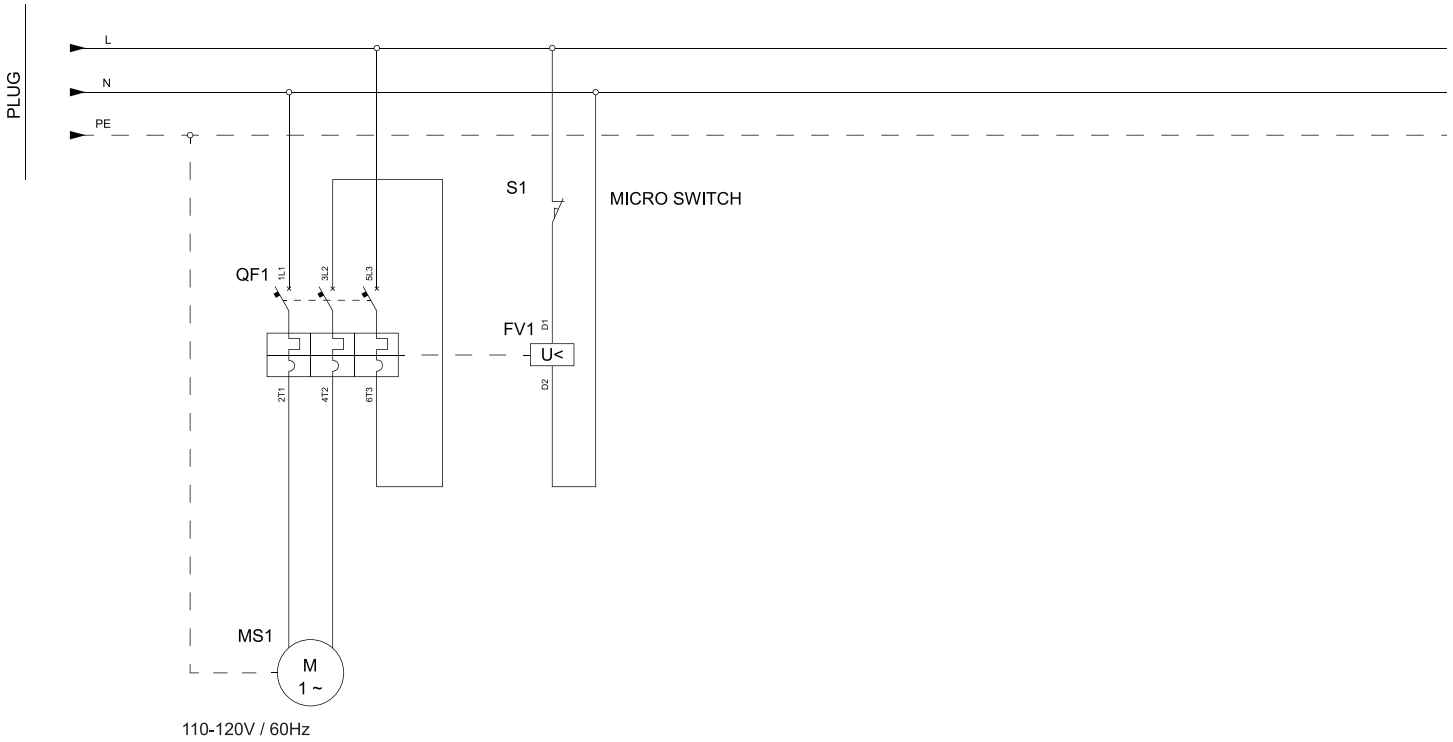

WARRANTY REGISTRATION

Thank you for purchasing an Trento product. To register your warranty for this product, complete the information below, tear off the card at the perforation and then send to the address specified below. You can also register online by visiting:

Merci d'avoir acheté un produit Trento. Pour enregistrer votre garantie pour ce produit, complétez les informations ci-dessous, détachez la carte au niveau de la perforation, puis l'envoyer à l'adresse spécifiée ci-dessous. Vous pouvez également vous inscrire en ligne en visitant:

Gracias por comprar un producto Trento usted. Para registrar su garantía para este producto, complete la información a continuación, cortar la tarjeta en la perforación y luego enviarlo a la dirección indicada a continuación. También puede registrarse en línea en:

<https://omcan.com/warranty-registration/>

For mailing in Canada

Pour postale au Canada

Por correo en Canadá

For mailing in the US

Pour diffusion aux États-Unis

Por correo en los EE.UU.

TRENTO

PRODUCT WARRANTY REGISTRATION

3115 Pepper Mill Court,
Mississauga, Ontario
Canada, L5L 4X5

TRENTO

PRODUCT WARRANTY REGISTRATION

4450 Witmer Industrial Estates, Unit 4,
Niagara Falls, New York
USA, 14305

or email to: trentoservice@trentoequipment.com



Purchaser's Information

Name: _____

Address: _____

City: _____ Province or State: _____ Postal or Zip: _____

Country: _____

Dealer from which Purchased: _____

Dealer City: _____ Dealer Province or State: _____

Invoice: _____

Model Name: _____ Model Number: _____

Machine Description: _____

Date of Purchase (MM/DD/YYYY): _____

Would you like to extend the warranty? Yes No

Company Name: _____

Telephone: _____

Email Address: _____

Type of Company:

Restaurant Bakery Deli

Butcher Supermarket Caterer

Institution (*specify*): _____

Other (*specify*): _____

Serial Number: _____

Date of Installation (MM/DD/YYYY): _____

Thank you for choosing Trento | Merci d'avoir choisi Trento | Gracias por elegir Trento

TRENTO

ELEVATING CULINARY EXCELLENCE

TRENTO IS A SIGNATURE LINE OF PROFESSIONAL
RESTAURANT EQUIPMENT FROM OMCAN
OFFERING PREMIUM EUROPEAN BRANDS TO THE
NORTH AMERICAN MARKET.

Thank you for your purchase!



Follow us on social media

@trentoequipment

