

PARTS BREAKDOWN

ITEM	MODEL
45959	SS-ES-0048-F

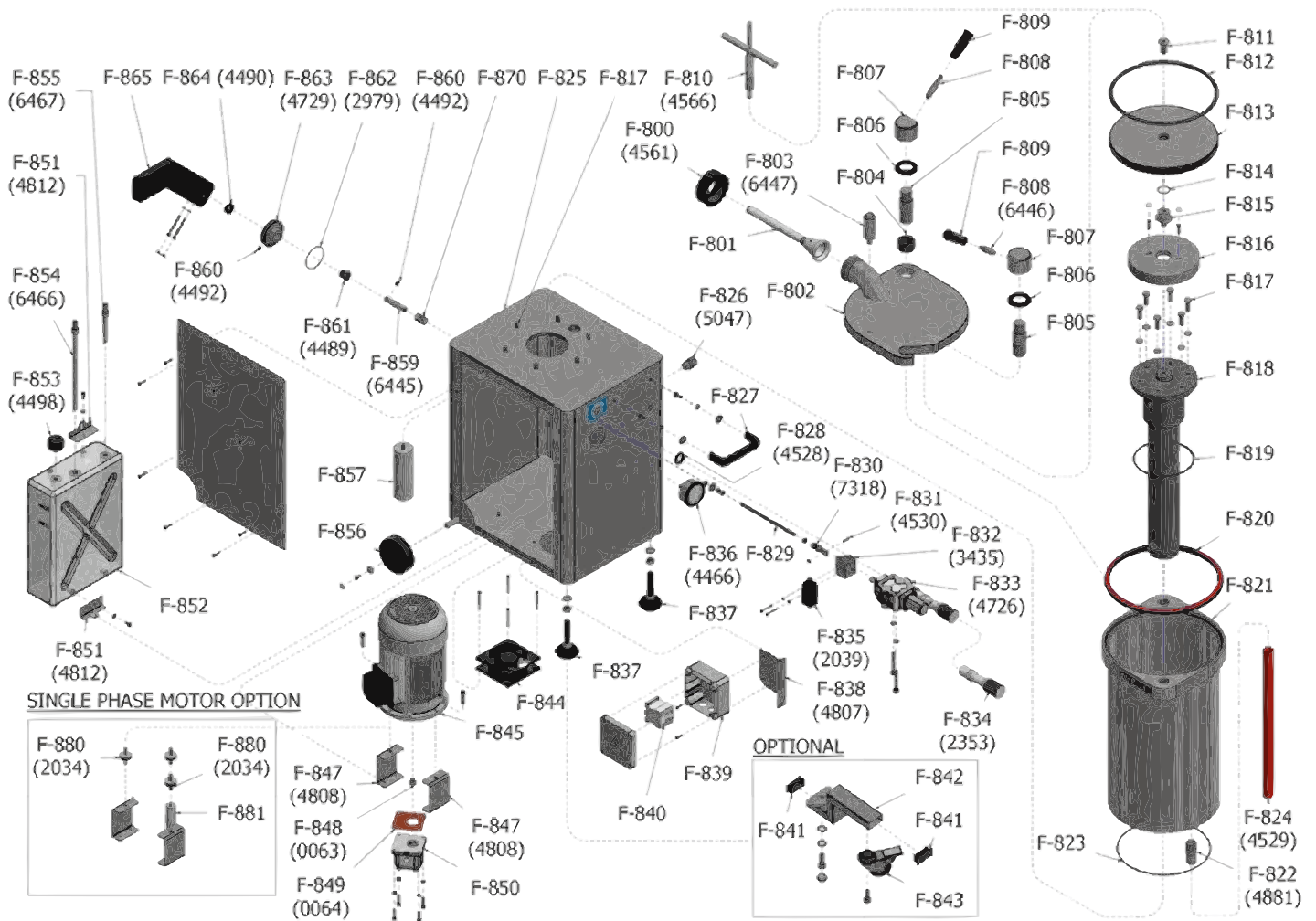

PARTS BREAKDOWN

ITEM	MODEL
45959	SS-ES-0048-F

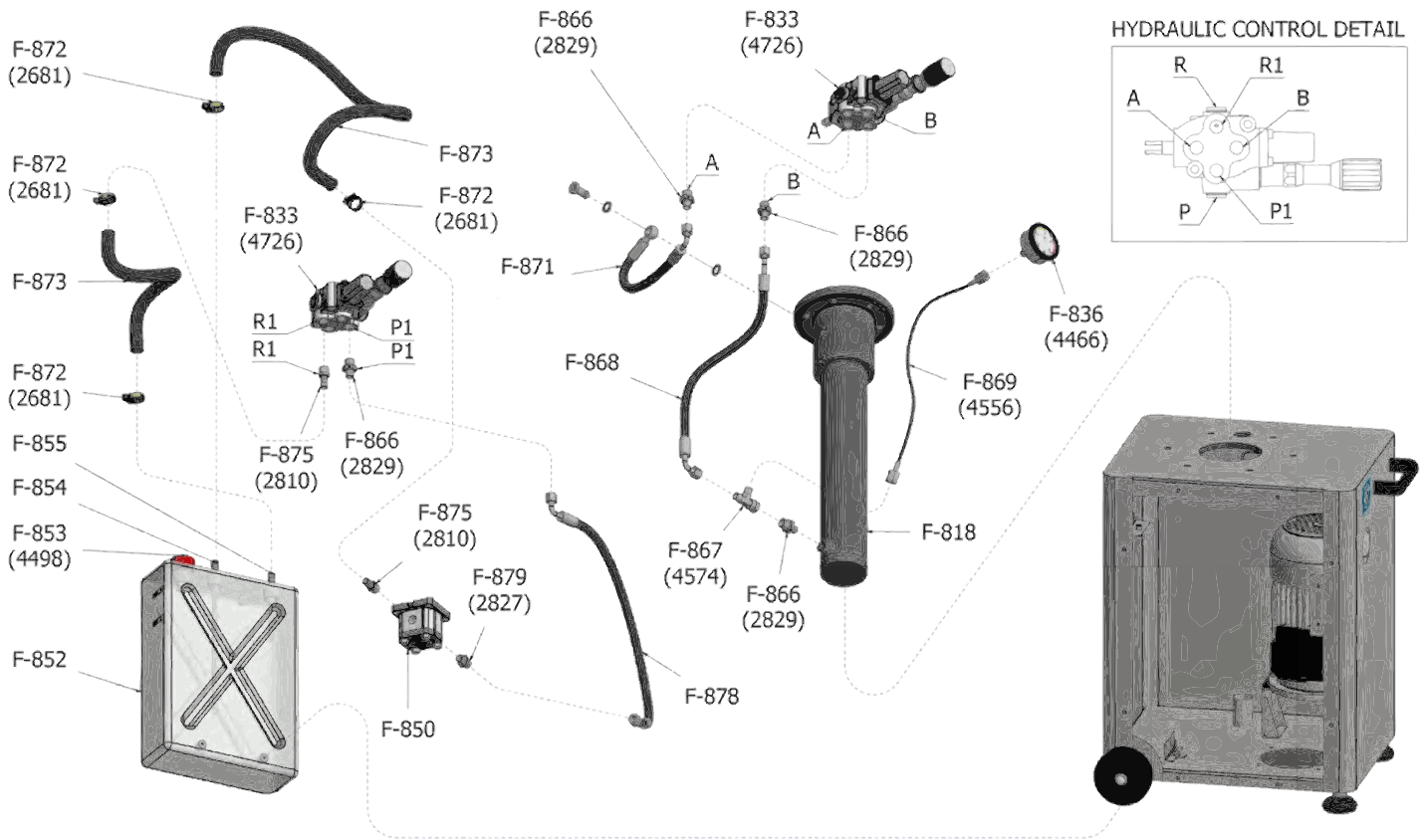

PARTS BREAKDOWN

ITEM	MODEL
45959	SS-ES-0048-F

Item No.	Description	Position	Item No.	Description	Position	Item No.	Description	Position
66842	Nozzle/Horn Retention Nut Black for 45959	F-800	66915	Threaded Tip Hydraulic Cylinder Bolt AISI303 for 45959	F-815	36037	Hydraulic Control Micro Switch Holder for 45959	F-832
66843	Nozzle/Horn Poliet. HD Translucent D.EXT.14 INT.10L.Use 160mm (6") for 45959	F-801	66916	Hood Clamp, Hydraulic Cylinder, Grey for 45959	F-816	66877	Hydraulic Control 102N8SA23X-340 with Pressure Knob for 45959	F-833
66844	Nozzle/Horn Poliet. HD Translucent D.EXT.20 INT.16L.Use 196mm (8") for 45959	F-801	66861	Stainless Steel Hexagonal Screw for 45959	F-817	31219	External Pressure Valve Control Assembly M1670/861, Black Knob for 45959	F-834
66845	Nozzle/Horn Poliet. HD Translucent D.EXT.30 INT.26L.Use 196mm (8") for 45959	F-801	AD193	Hydraulic Cylinder for 45959	F-818	16524	Micro Position Detector, Comepi Metal Wheel for 45959	F-835
66911	Stainless Steel Lid without Accessories for 45959	F-802	66918	O-Ring, Int. Diam. 145x5, Hydraulic Cylinder for 45959	F-819	66878	Pressure Gauge D.63, Wika 213.53, 0-200 Bar, Thread 1-4" for 45959	F-836
66847	Lid Opening Lever AISI303 for 45959	F-803	66919	Lid Seal Polyurethane Red for 45959	F-820	66879	Foot, Stainless Steel for 45959	F-837
66848	Bras Bushing B11 Lid for 45959	F-804	66920	Fixed Dough Barrel for 45959	F-821	66880	Holder Isolating Box for 45959	F-838
66849	Stainless Steel Bolt, Lid for 45959	F-805	AF858	Deposit Drainage Pipe D.27 L.62 Gas 3/4" for 45959	F-822	36042	Isolating Box, Legrand 100x100x55mm Code 92138 for 45959	F-839
AD191	Washer for Lid Lock Nut, Bronze B7 for 45959	F-806	66921	O-Ring, Int. Diam. 235x4, Flange Dough Barrel for 45959	F-823	66048	Isolating Box, IDE 162x116x76, Polycarbonate (H UL-CSA +110V) for 45959	F-839
66851	Nut for Lid Lock AISI303 for 45959	F-807	66868	Transparent Fabric Hose PVC D.32x25, Deposit Drain for 45959	F-824	79579	Contactor, LS MC-22B AC 110V/60&50Hz 1A1B EXP A.C. 22 AMP for 45959	F-840
66852	Lever for Lid Lock Nut AISI303, without Black Knob for 45959	F-808	66922	Cabinet with Accessories for 45959	F-825	44093	Contactor 6A 208V/60HZ/3 for 45959	F-840
66853	Knob Black Thread M10 80mm for 45959	F-809	66870	Grommet, S-Tec 5308959 M20x1,5/13 Poliamyde, Grey for 45959	F-826	44094	Contactor 6A 220V-208V/60Hz/1-3 for 45959	F-840
66854	Spanner/Wrench, Piston Extractor for 45959	F-810	66923	Handle M8 for 45959	F-827	66881	Cap, Kapsto, GPN270, Swivel Castors for 45959	F-841
66855	CSK Allen Screw, Stainless Steel DIN7991 for 45959	F-811	66872	Wall Pass-Through D.34/21,8x6mm EPDM Black 70 SH for 45959	F-828	66882	Extension Swivel Castor AISI304 for 45959	F-842
66912	Piston Gasket, O-Ring, Red Silicone (1*Piston) for 45959	F-812	66924	Threaded Rod Hydraulic Control M8 AISI304 for 45959	F-829	66883	Swivel Caster Black/Stainless Steel with Brake for 45959	F-843
66913	Piston, Stainless Steel, without O-Ring for 45959	F-813	19415	Internal Fork, Hydraulic Control Activator, Stainless Steel for 45959	F-830	66884	Fan, 120x120x38 110V 50/60HZ 1-Phase 156 M3/H 115V UL/CSA for 45959	F-844
66914	O-Ring, Int. Diam. 29x2 Threaded Tip Piston for 45959	F-814	66875	Cylindrical Pin, D.6x19,5 Stainless Steel for 45959	F-831	39059	Air Extraction Fan 220V 1PH for 45959	F-844

PARTS BREAKDOWN

ITEM	MODEL
45959	SS-ES-0048-F

Item No.	Description	Position	Item No.	Description	Position	Item No.	Description	Position
66925	Motor 110V-60HZ-1 for 45959	F-845	AF864	Capacitor 110V-60HZ for 45959	F-857	AF862	Compression Spring for 45959	F-870
19410	Motor 3-Phase H 3/208/220V-60HZ-0.75HP-0.55KW 1700 RPM for 45959	F-845	AF863	Capacitor 230/220V-50HZ for 45959	F-857	66907	Hose, 290mm R1T1/4 ESF1/4-TL90HG8L, Top Cylin-Hydraulic Control for 45959	F-871
36046	Motor 1-Phase 1/220V-60HZ-1.75HP-1 3KW-1700 Clockwise Rotation Capac.40 for 45959	F-845	66895	Activator Knee Lever D.15 L.70mm AISI303 for 45959	F-859	66908	Hose Clamp, Mikalor D.12-20/9 for Hydr. Oil Drain Tube NH for 45959	F-872
66887	Motor Mounting Bracket for 45959	F-847	66896	Pedal Brass Bushing, B11 A-6-9-12 for 45959	F-860	66909	Rubber Hose Klemine-20 Bar D.12x20 for 45959	F-873
31222	Motor-Pump Coupling for 45959	F-848	66897	Brass Bushing, B11 B-15-20-20/25-3 with Collar for 45959	F-861	61763	Nozzle Cover, Rubber 12 Male Thread 3/8" (Draining Hose) for 45959	F-875
31221	Seal, Vellumoid 1625-1 for Pump Type L for 45959	F-849	66898	O-Ring, Int. Diam. 61x2 for 45959	F-862	66910	Hose, R1T1/4 TL90HG8L-TL45HG8L (Hydraulic Pump Control) for 45959	F-878
36028	Gear Pump for 45959	F-850	66899	Support Knee Lever AISI304 for 45959	F-863	65038	Hydraulic Union, Simple, GE8LR 1/4" BSP for 45959	F-879
66889	Support Oil Reservoir/Cabinet for 45959	F-851	66900	Gasket, Knee Lever for 45959	F-864	19253	Rubber Cylindrical Foot Series T-30-10 Black (Antivibration for Motor NH) for 45959	F-880
66890	Internal Oil Reservoir, Poliprop. White for 45959	F-852	AF861	Knee Lever, Black for 45959	F-865	AD192	Motor Mounting Bracket for 45959	F-881
66891	Oil Cap Depressurized Red for 45959	F-853	66902	Hydraulic Union, Simple, GE8LR 3/8" BSP for 45959	F-866	AC974	Washer, Stainless Steel, Straight D.6,4-M6 DIN125 for 45959	
66892	Oil Return Pipe D.10 L.120mm for 45959	F-854	66903	T Joint EVL-08 (Outlet Control to Hydraulic Cylinder + Gauge) for 45959	F-867	AC973	Allen Screw, Stainless Steel M6x55 DIN912 for 45959	
66893	Oil Suction Pipe D.10 L.270mm for 45959	F-855	66904	Hose, R1T1/4 TL90HG8L-TL45HG8L, Bottom Cylin-Hydr Control for 45959	F-868			
36110	Wheel, Nylon for 45959	F-856	66905	Hose, Pressure Gauge 1/4", Length 500mm for 45959	F-869			