



## Installation Instructions for Gas Hose Connection Kits

**⚠️WARNING:** Please read and follow the following instructions carefully. Failure to do so could result in severe injury or death. The color of the pipe coating might vary.

1. Installation of this kit must be in compliance with the National Fuel Gas Code (ANSI Z223.1) and all local gas installation codes. The flexible gas connector in this kit complies with ANSI Z21.69/CSA 6.16. for movable gas appliances. The quick disconnect fitting in this kit complies with ANSI Z21.41/CSA 6.9 for use with gas fuel appliances.
2. Installation and testing of this kit must be performed by qualified personnel.
3. The restraining cable provided in this kit should always be connected when the appliance is in use and must be securely attached per the Restraining Cable Instructions provided in this installation instruction. A restraining cable is required for all movable gas appliances per ANSI Z223.1 & ANSI Z21.69.
4. The gas outlet should be in the same room as the appliance. The flexible gas connector must not be concealed within or run through any wall, floor, and drywall or partition wall.
5. A gas shutoff valve must be installed at the gas supply to the flexible gas connector and must be located within 6" of the appliance it is being attached to.
6. For movable appliances, pulling and pushing of the appliance should be kept to a minimum and limited to cleaning or maintenance.
7. The gas supply must be turned off and the appliance must be disconnected prior to movement.
8. The final assembly should be tested for any leaks per the National Fuel Gas Code ANSI Z233.1, NFPA 54, or CSA B149.1, Natural Gas and Propane Installation Code. Leak test solutions may cause corrosion, therefore use water to rinse the areas after testing.
9. The use of strong chemicals or cleaning products on the flexible gas connectors may cause permanent damage, such as acids, solvents or other chlorinated chemicals. In case of contact, rinse the flexible gas connector with water and dry thoroughly.
10. The flexible gas connector is to be used only on piping systems with a maximum gas pressure of ½ psi (3.45kPa). The flexible gas connectors in this kit are suitable for natural, manufactured, mixed and liquefied petroleum gases and LP gas air mixtures.
11. The flexible gas connector should not be kinked, twisted, or bent when installed. Avoid contact with wiring, substances or sharp edges as all of these may damage the flexible gas connector.
12. The flexible gas connector and connection points should not be reused for other appliances. Each appliance should have its own flexible gas connector and connection points.
13. The quick disconnect should be installed in a way that the gas follows the gas flow arrows indicated on the quick disconnect.
14. Do not insert any instrument, screwdrivers, probes, etc., into the quick disconnect. The valve can be damaged potentially resulting in a leak.
15. The quick disconnect is not meant for use with dual fed gas manifold line up applications, for this type of application use a gas shutoff valve.

## **PREPARATION FOR INSTALLATION**

**Step 1:** Before installing this kit, you must carefully read this full set of instructions including the WARNING section of this instruction set.

**Step 2:** Make sure the main gas line and the connecting gas shutoff valve are shut-off.

**Step 3:** Make sure the flexible gas connector has the adequate length to ensure there is no bending or twisting, which may cause strain and tension ultimately damaging the flexible gas connector. (See "Common Installation Mistakes" Section).

**Step 4:** If a gas shutoff valve is included in your kit, follow the Gas Shutoff Valve Installation Instructions. If not, proceed to the Flexible Gas Connector Installation Instructions.

**Step 5:** After installing the flexible gas connector proceed to install the restraining cable per the Restraining Cable Kit Installation Instructions.

**Step 6:** After installing the restraining cable, if your kit includes a Wheel Positioning System, proceed to the Wheel Positioning System Installation Instructions.

## **FULL PORT GAS SHUTOFF VALVE INSTALLATION INSTRUCTIONS**

**Step 1:** Apply thread sealant to the gas supply line male thread.

**Step 2:** Thread the gas shutoff valve onto the gas supply line male thread and wrench tighten.

**Step 3:** Install a fitting if needed for better positioning of the flexible gas connector.

**Step 4:** Follow the Flexible Gas Connector Installation Instructions.

**FLEXIBLE GAS CONNECTOR INSTALLATION INSTRUCTIONS**

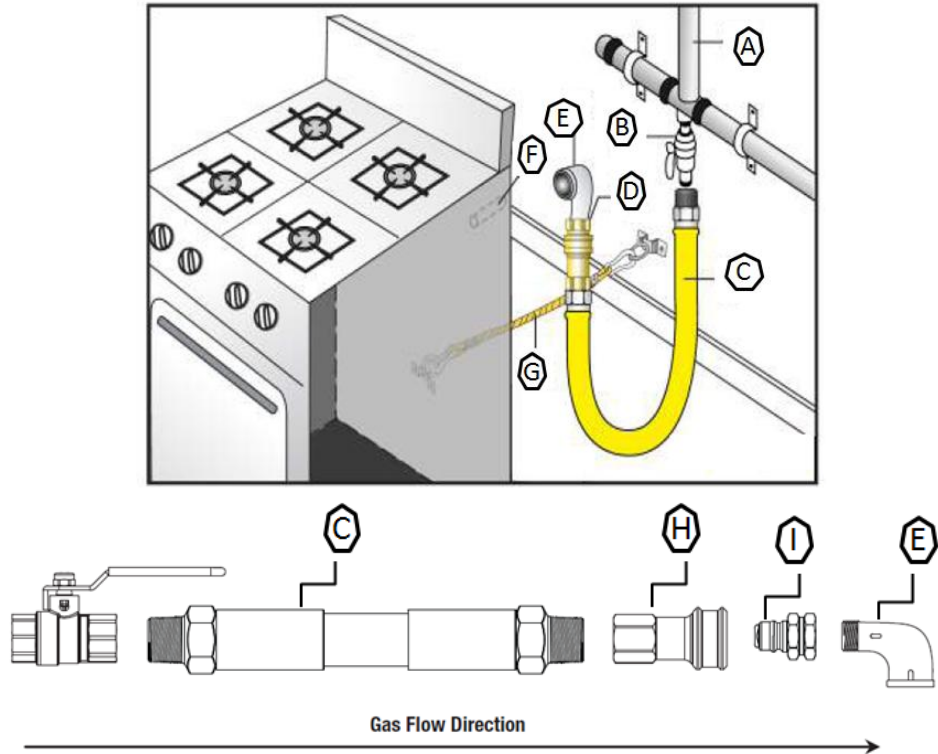

Fig 1

|   |                                     |   |  |
|---|-------------------------------------|---|--|
| A | Gas manifold(Gas supply pipe)       | F | Appliance gas feeding pipe             |
| B | Gas shut-off ball valve             | G | Restraining cable                      |
| C | Gas stainless steel corrugated pipe | H | Quick disconnect coupling half(Female) |
| D | Quick disconnect                    | I | Quick disconnect Nipple half           |
| E | Street elbow                        |   |  |

Fig 1

**Fig 1(Option 1): Quick Disconnect attached at the appliance side.**

**• Gas Supply Side:**

**Step 1:** Apply thread sealant to the threads at one end of the flexible gas connector.

**Step 2:** Thread the end of the flexible gas connector into the supply connection and tighten it with a wrench.

**• Appliance Side:**

**Step 3:** If not using a fitting skip to step 5. Apply thread sealant to the appliance’s male threaded connector, and thread the fitting onto the appliance’s male threaded connector and tighten with a wrench.

**Step 4:** Apply thread sealant to the fittings MIP side.

**Step 5:** Separate the quick-disconnect body from the quick disconnect fitting by squeezing and pulling the sleeve toward the gas

inlet side of the quick disconnect body. The quick disconnect fitting should spring loose. Thread the quick disconnect fitting onto the male fitting threads and tighten with a wrench.

**CAUTION:** The gas flow must follow the flow direction arrows on the quick disconnect.

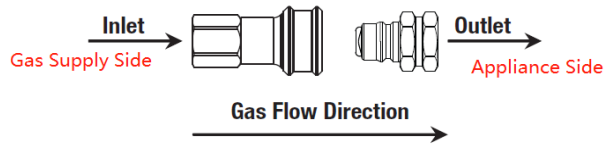

**Step 6:** Apply thread sealant to the other end of the flexible gas connector. Thread the quick disconnect body onto the flexible gas connector and wrench tighten.

**Step 7:** Connect the quick disconnect female body into the quick disconnect fitting.

**Step 8:** Check for tightness on all connections.

**Step 9:** Leak test per National Fuel Gas Code Z223.1, NFPA 54 or CSA B149.1, Natural Gas and Propane Gas Installation Code.

**Step 10:** Make sure that the flexible gas connector can freely move without obstruction, kinks or damage from sharp edges, caster, etc.

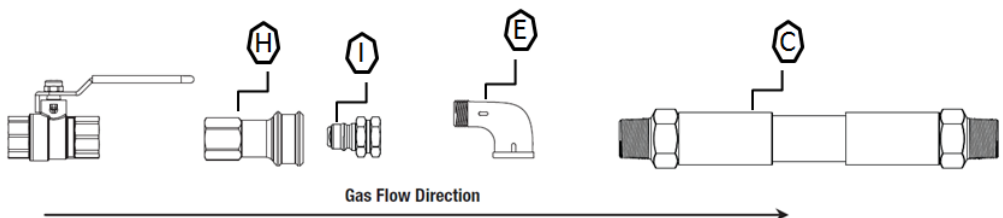
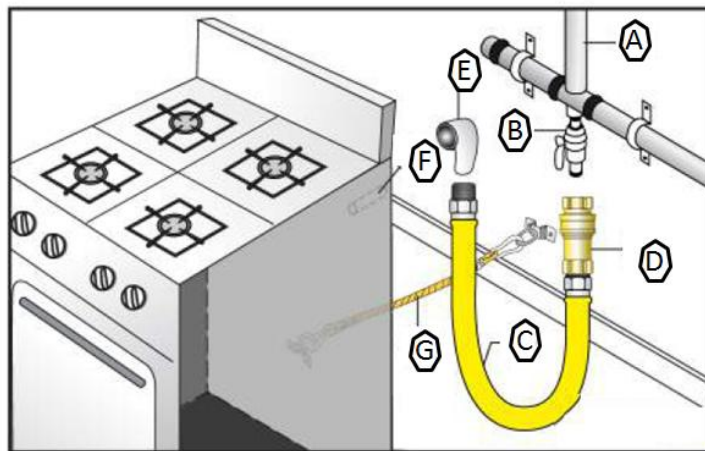

Fig 2

Fig 2(Option 2): Quick Disconnect attached at the gas supply line.

**⚠WARNING: Option 2 installation may require additional female–female coupling and/or male–male coupling which are not included in the kit. Check additional necessary parts before installation.**

**• Gas Supply Side:**

**Step 1:** Separate the quick disconnect body from the quick disconnect fitting.

**Step 2:** Apply thread sealant to the threads of the gas supply male threaded fitting.

**Step 3:** Thread the quick disconnect body onto the threads of the gas supply male thread fitting.

**Step 4:** Apply thread sealant to the threads on one end of the flexible gas connector and wrench tighten.

**Step 5:** Thread the end of the flexible gas connector into the quick disconnect fitting and tighten it with a wrench.

**⚠CAUTION:** The gas flow must follow the flow direction arrows on the quick disconnect on the quick disconnect.

**• Appliance Side:**

**Step 6:** Apply thread sealant to the appliance’s male threaded connector, and thread a fitting onto the appliance’s male threaded connector and wrench tighten.

**Step 7:** Apply thread sealant to the male fitting threads.

**Step 8:** For this step, a FxF coupler will be required. Insert the male fitting threads into the FxF threaded coupler.

**Step 9:** Apply thread sealant to the other end of the flexible gas connector. Thread the flexible gas connector to the FxF coupler and wrench tighten.

**Step 10:** Connect the quick disconnect fitting to the quick disconnect body.

**Step 11:** Check for tightness on all connections.

**Step 12:** Leak test per National Fuel Gas Code Z223.1, NFPA 54 or CSA B149.1, Natural Gas and Propane Gas Installation Code.

**Step 13:** Make sure that the flexible gas connector can freely move without obstruction, kinks.

## **RESTRAINING CABLE KIT INSTALLATION INSTRUCTIONS**

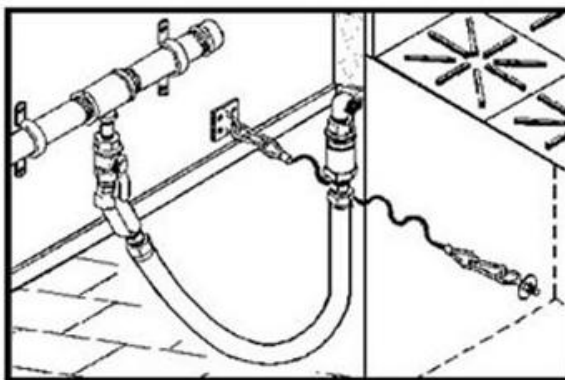

**⚠WARNING:** Per ANSI Z223.1 & ANSI Z21.69, the restraining cable must remain installed and connected while the flexible gas connector is installed.

**⚠WARNING:** Before drilling into any appliance or wall be sure to check that the drill bit will not hit any necessary operating part of the appliance or any pipe or electrical wire/conduit behind a wall.

**⚠WARNING:** Install the restraining cable parallel to the gas appliance connector.

**Step 1:** Drill out a hole in the wall and install the metal claw anchor by using a washer against the wall.

**Step 2:** Drill out a hole in the appliance and install the eye bolt with a washer through the hole.

**Step 3:** Add another washer on the eye bolt side and secure it with the locking nut.

**Step 4:** Attach the restraining cable to the anchor points by clipping the hooks onto the metal eyelets.

**Step 5:** Pull the appliance away from the wall to ensure the restraining cable does not allow or the gas connector to be fully

extended.

**⚠CAUTION:** To ensure install meets code requirements confirm restraining kit does not allow connector to be strained.

**⚠CAUTION:** Do not turn on the gas supply line or the appliance until reinstallation of the flexible gas connector is complete.

### **CLEANING BEHIND APPLIANCE**

#### **• Disconnecting the Flexible Gas Connector**

**Step 1:** Turn off the appliance and gas supply line.

**Step 2:** Pull the appliance away from the wall until the restraining cable is extended.

**Step 3:** Disconnect the appliance from power source.

**Step 4:** Disconnect the flexible gas connector by pulling back the sleeve on the quick disconnect body. Do not put stress on the connector.

**Step 5:** Detach the clip of the restraining cable from the anchor points.

#### **• Reconnecting the Flexible Gas Connector**

**⚠CAUTION:** Do not turn on the gas supply line or the appliance until reinstallation of the flexible gas connector is complete.

**Step 1:** Reconnect the restraining cable to the anchor points by attaching the hook.

**Step 2:** Reconnect the quick disconnect by pulling on the sleeve on the body and pushing the fitting into the body until it clips into place.

**Step 3:** Once the fitting clips into place, slightly pull onto the flexible gas connector to make sure the connection is secure.

**Step 4:** Turn on the gas supply line and check for leaks.

### Common Installation Mistakes

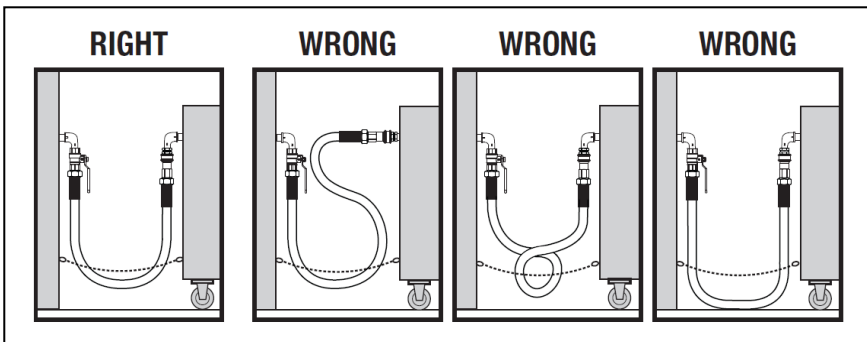

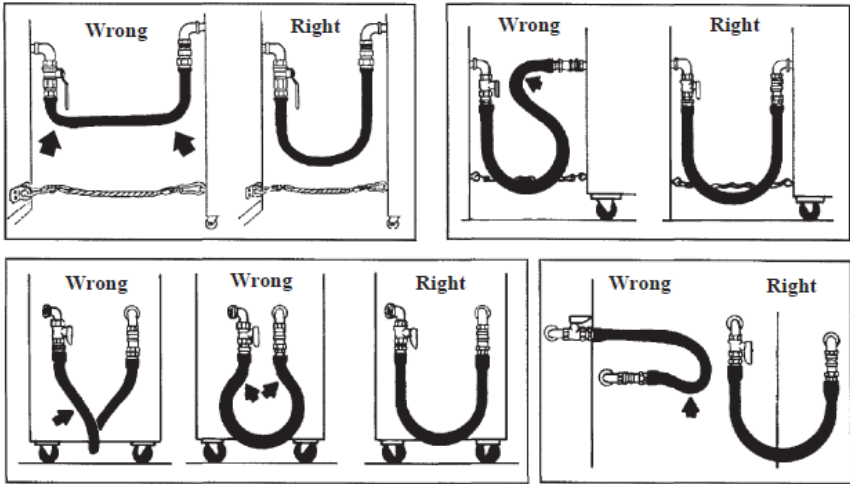

- No sharp bends with a radius less than 10 inches.
- No twists
- No double bends
- Do not drag on the floor
- Make sure to keep a 10-inch radius between the gas supply and the appliance supply to prevent them from hitting when you push the appliance into place.



