

II
1:2

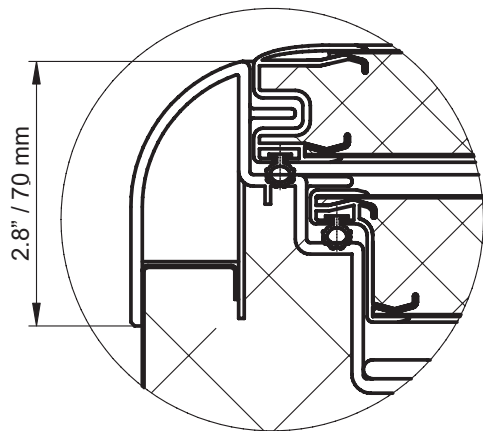

I
1:2

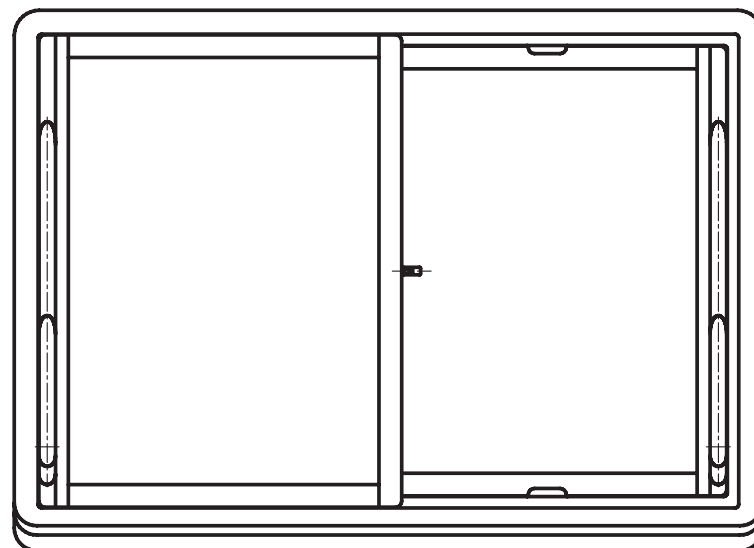
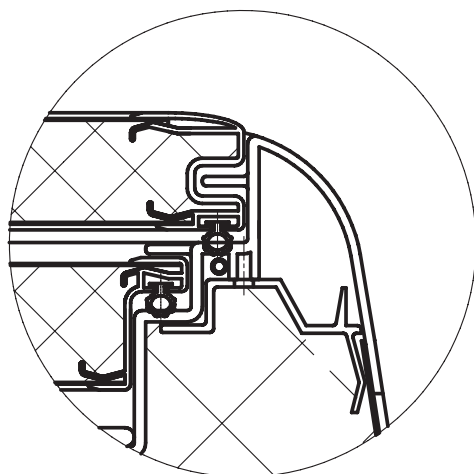

ITEM 46493